

# Steam/Hot Water Unit Heaters

Horizontal Air Delivery Model UHH

Vertical Air Delivery Model UDH

Model UHH



Model UDH



Units are listed by the  
Canadian Standards Association



# Table of Contents

---

## Design Features

Horizontal Air Delivery Model UHH.....	3
Vertical Air Delivery Model UDH .....	4

## Dimensional Data

Horizontal Air Delivery Model UHH.....	5
Vertical Air Delivery Model UDH .....	6

## Performance Data

### Model UHH

Model UHH Hot Water - High Motor Speed .....	7
Model UHH Hot Water - Reduced Motor Speed ....	7
Model UHH Steam - High Motor Speed.....	8
Model UHH Steam - Reduced Motor Speed.....	8
Horizontal Model UHH - Motor Data.....	9

### Model UDH

Model UDH Hot Water - High Motor Speed .....	10
Model UDH Steam - High Motor Speed.....	10
Vertical Model UDH - Motor Data.....	11

## Application Guidelines

Horizontal Air Delivery Unit Heaters .....	12
Vertical Air Delivery Unit Heaters .....	12
Other Factors That Can Influence Selection.....	12
Selection for Applications Where Sound is a Factor .....	12
Building or Room Sound Zones.....	12

## Locating Unit Heaters..... 13

Monitor Type Building.....	14
Mill Type Building .....	14
Warehouse Building .....	14
Office/Manufacturing Building .....	14
Narrow Building.....	14

## Automatic Control..... 15

## Selection Formulas & Data..... 16- 23

Example 1: Hot Water Calculation, Horizontal Unit.....	16
Hot Water Unit Heater Mounting Height Correction Factors.....	16
Hot Water Calculation Formulas .....	17

Hot Water Htng Cap. Conversion Factors.....	18
Correction Factors for Varying Water Temperature Drop.....	18
Ethylene Glycol Correction Factors.....	18
Example 2: Steam Calculation, Horizontal Unit...19	
Steam Calculation Formulas .....	20
Steam Htng Cap. Conversion Factors, Horizontal Delivery.....	20
Air Temperature Rise Conversion Factors, Horizontal Delivery.....	21
Properties of Steam .....	21
Steam Unit Heater Mounting Height Correction Factors .....	21
Example 3: Hot Water Calculation, Vertical Unit .....	22
Example 4: Steam Calculation, Vertical Unit.....	22
Steam Htng Capacity Conversion Factors, Vertical Delivery.....	23
Air Temperature Rise Conversion Factors, Vertical Delivery.....	23

## Motor Data & Power Codes ..... 24

Model UHH & UDH .....	24
-----------------------	----

## Performance Curves ..... 25-28

## Options/Accessories

Unit Heater Factory Mounted Options.....	29
Unit Heater Field Installed Options.....	29
Field Installed Options & Accessories for Vertical Air Delivery Models .....	30-31

## Piping For Unit Heaters..... 32

## Guide Specifications ..... 33-34

Horizontal Air Delivery Model UHH.....	33
Vertical Air Delivery Model UDH .....	34

## Metric & English Conversion..... 35

# Design Features

---

## Horizontal Air Delivery Model UHH



### Coil

- Sturdy, mechanically bonded copper/aluminum coil with 12 fins per inch with 1/2" nominal tubes
- High Btu capacity
- Coils are tested at 275 psig air under water. Coils are suitable for operating up to 150 psig steam or 220 psig water and 375°F
- Fins are continuous across width and depth of coil and are vertically oriented to resist collection of dirt and foreign particles

### Enclosure

- Rugged 18-gauge casing protects against abuse
- Two piece enclosure allows for ease of maintenance
- Durable and attractive gray textured epoxy powder coating is standard

### Louvers

- Adjustable horizontal louvers are standard for adjustment of air distribution
- Constructed of rigid 18-gauge steel
- Color matched to enclosure for consistent appearance

### Piping Connection

- NPT connections permit quick and easy piping with no additional components needed
- Mounted to casing for rigidity

### Mounting Hardware

- Heavy duty threaded hardware allows unit to be mounted with threaded rod
- Optional pipe hanger kit available for mounting unit with threaded pipe

### Formed Air Inlet/Outlet

- Die-formed venturi inlet draws air smoothly into unit for maximum airflow

### Motor

- All motors are totally enclosed, permanently lubricated for extended, reliable motor life
- Low operating cost and quiet operation
- When teamed with variable speed control, fan speed adjustment is infinite
- Equipped with thermal overload protection

### Fan

- Lightweight and dynamically balanced
- Designed to move air efficiently with minimum power requirement

### Finger Proof Fan Guard

- Standard equipment per (CSA, OSHA)
- Securely mounts motor to unit while absorbing vibration with rubber isolation mounts

# Design Features

---

## Vertical Air Delivery Model UDH



### Coil

- Sturdy, mechanically bonded copper/aluminum formed coil with 12 fins per inch with 1/2" nominal tubes between extra-heavy steel pipe connections
- High Btu Capacity
- Coils are tested at 275 psig air under water. Coils are suitable for operating up to 150 psig steam or 220 psig water and 375°F
- Fins are continuous along width and depth and are vertically oriented to resist collection of dirt and foreign particles

### Formed Air Inlet/Outlet

- Die-formed venturi outlet draws air through unit for maximum airflow

### Air Diffusion

- Multiple arrangements available for unlimited air diffusion patterns
- Accessories are finished with epoxy-based powder coating to match unit

### Finger Proof Fan Guard

- Standard equipment per (CSA, OSHA)
- Gives 100% safety confidence for mounting in any area
- Constructed of painted steel rod

### Fan

- Lightweight, dynamically balanced
- Designed to move air efficiently and quietly with minimum power requirement

### Casing

- Rugged 16-gauge casing protects against abuse
- Separate top and bottom enclosure pieces allow for ease of maintenance
- Attractive gray textured epoxy powder coating is standard and durable

### Motor

- All motors are totally enclosed, permanently lubricated for extended, reliable motor life
- Low operating cost and quiet operation
- Designed for easy motor removal, important for high ceiling applications
- Equipped with thermal overload protection
- High efficiency

### Mounting Hardware

- Heavy duty threaded hardware allows unit to be mounted with threaded rod
- Optional pipe hanger kit (requires 2) available for mounting unit with threaded pipe

### Junction Box

- All unit wiring is contained in an electrical junction box that is mounted to the unit heater casing

### Piping Connection

- Durable steel header has external
- NPT threads for easy connection

# Dimensional Data

## Horizontal Air Delivery Model UHH



### Unit Size 18 through 86

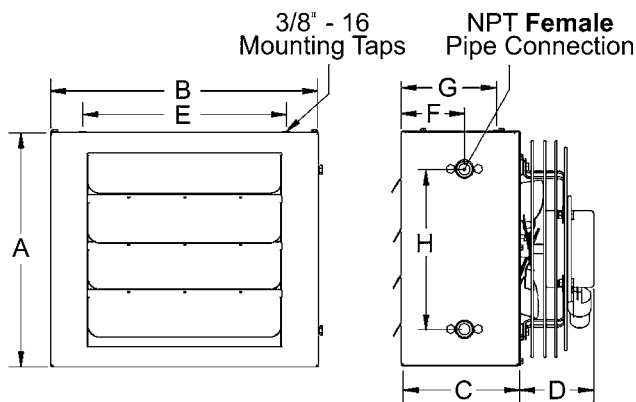

### Unit Size 108 through 340

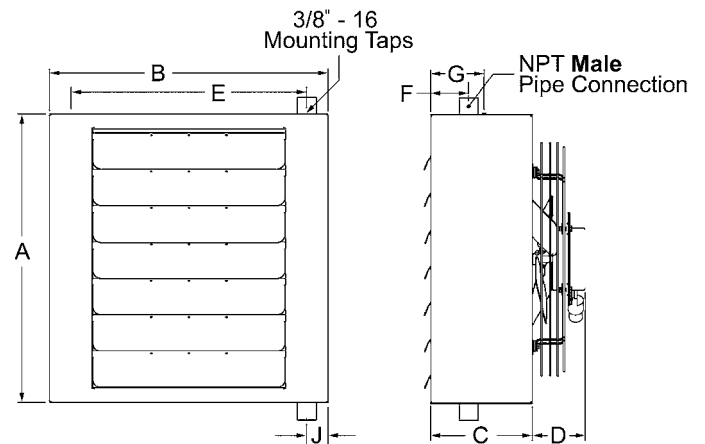

**Table 1. Dimensions – Model UHH**

Unit Size	A	B	C	D	E	F	G	H	J	NPT CONNECTIONS	FAN DIAMETER	APPROX. SHIPPING WT. LB.
UHH-18	15	16 7/8	7 1/2	4 1/2	12	3 1/2	5	10	—	3/4	9	18
UHH-24	15	16 7/8	7 1/2	4 1/2	12	3 1/2	5	10	—	3/4	9	19
UHH-33	19	19 3/4	7 1/2	4 3/4	12	3 1/2	5	14	—	3/4	12	35
UHH-47	19	19 3/4	7 1/2	4 3/4	12	3 1/2	5	14	—	3/4	12	36
UHH-63	19	25 3/4	8 1/2	4 3/4	18	3 1/2	5	14	—	3/4	14	51
UHH-86	19	25 3/4	8 1/2	4 3/4	18	3 1/2	5	14	—	3/4	14	52
UHH-108	27	25 7/8	9 1/2	6 1/4	18	3 1/2	5 1/4	—	2	1 1/2	18	76
UHH-121	27	25 7/8	9 1/2	6 1/4	18	3 1/2	5 1/4	—	2	1 1/2	18	77
UHH-165	27	31 7/8	10	6 1/4	24 7/8	3 1/2	6 1/4	—	2	1 1/2	20	95
UHH-193	27	31 7/8	10	8 3/8	24 7/8	3 1/2	6 1/4	—	2	1 1/2	20	96
UHH-258	33	40 13/16	11	8 3/8	32 7/8	3 1/2	6 1/4	—	2 1/4	2	22	165
UHH-290	33	40 13/16	11	8 3/8	32 7/8	3 1/2	6 1/4	—	2 1/4	2	22	167
UHH-340	39	40 13/16	12	8 3/8	32 7/8	3 1/2	7 1/4	—	2 1/4	2	24	182

**Notes:**

1. All dimensions in inches.
2. UHH-18 through UHH-86 have side NPT **female** pipe connections.
3. UHH-108 through UHH-340 have top and bottom NPT **male** pipe connections.
4. Units should be mounted a minimum of 5" from wall.

# Dimensional Data

## Vertical Air Delivery Model UDH



### Unit Size 42, 59

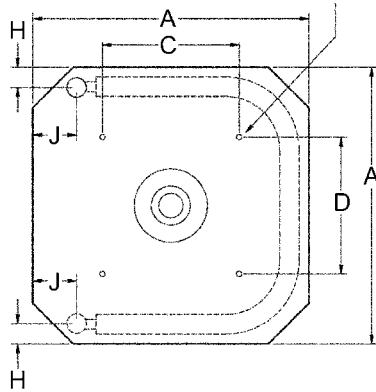

4-Mounting Holes  
1/2" - 13 Tap

### Unit Size 78 through 610

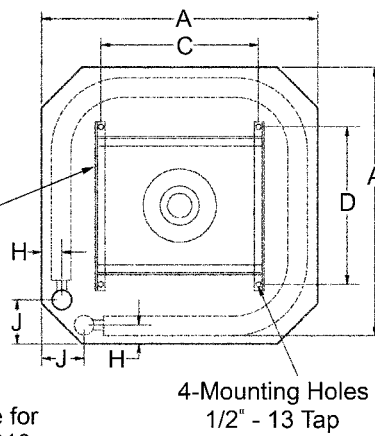

Angle Iron Frame for  
UD-193 to UD-610

4-Mounting Holes  
1/2" - 13 Tap

Steam Supply and  
Hot Water Return  
NPT Connection

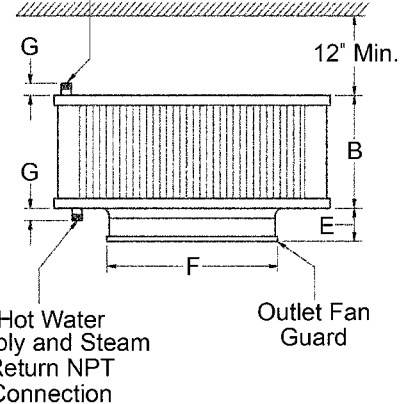

Hot Water  
Supply and Steam  
Return NPT  
Connection

Outlet Fan  
Guard

**Table 2. Dimensions – Model UDH**

UNIT SIZE	A	B	C	D	E	F	G	H	I	MALE NPT CONNECTIONS	FAN DIAMETER	APPROX. SHIPPING WT. LB.
UDH-42, 59	23	6-3/8	12	12	3-1/8	15	2-3/4	1-7/8	3-1/4	1-1/2	13-3/4	52
UDH-78, 95	25	6-3/8	13	13	3-1/8	17	2-3/4	1-7/8	3-1/4	1-1/2	15-3/4	64
UDH-139, 161	35	10-3/8	14-7/16	14-7/16	3-1/8	18-7/8	2-3/4	2	3-1.4	1-1/2	17-3/4	99
UDH-193, 212	30	12-3/8	19	17	4	20-7/8	2-3/4	2	3-5/8	2	19-3/4	126
UDH-247, 279	35	12-3/8	20	18	4	22-7/8	2-3/4	2	3-5/8	2	21-3/4	154
UDH-333, 385	35	18-3/8	21	21	4	24-3/4	2-3/4	2-1/2	4-1/2	2-1/2	23-3/4	189
UDH-510	43	18-3/8	25	25	4	28-3/4	2-3/4	2-1/2	4-1/2	2-1/2	27-3/4	270
UDH-610	43	18-3/8	27	27	4	30-3/4	2-3/4	2-1/2	4-1/2	2-1/2	29-3/4	290

**Note:**

All dimensions in inches.

# Performance Data

## Horizontal Air Delivery Model UHH (Hot Water)

Table 3. Hot Water (High Motor Speed)

Model Type UHH	Unit Size	Btu/Hr.	WATER DATA			AIR DATA						MOTOR DATA	
			GPM	Pressure Drop (Ft. of water)	Min./Max GPM	Cfm	Outlet Velocity FPM	Final Air Temp. (°F)	Max. Mounting Height (ft.)*	Heat Spread@ Max Height*	Sound Class**	HP	Approx. RPM
HORIZONTAL AIR DELIVERY	UHH-18	13,000	1.3	0.49	0.3/5.0	400	500	90	9	18	II	1/30	1550
	UHH-24	17,300	1.7	0.83	0.3/5.0	450	570	96	10	20	II	1/30	1550
	UHH-33	24,500	2.5	0.12	0.4/10.0	630	495	96	11	22	II	1/15	1550
	UHH-47	33,800	3.4	0.21	0.4/10.0	730	580	103	13	26	III	1/15	1550
	UHH-63	46,500	4.7	0.47	0.5/15.0	1120	590	98	15	30	III	1/10	1550
	UHH-86	61,900	6.2	0.79	0.5/15.0	1340	710	103	16	31	III	1/10	1550
	UHH-108	81,000	8.1	0.85	0.5/20.0	1550	605	108	16	33	III	1/8	1075
	UHH-121	90,000	9.0	1.04	0.7/20.0	1775	690	107	17	36	III	1/8	1075
	UHH-165	133,000	13.3	2.48	2.0/30.0	2500	735	109	18	38	IV	1/4	1075
	UHH-193	156,000	15.6	3.35	2.0/30.0	2900	850	110	19	40	IV	1/4	1075
	UHH-258	198,000	19.8	3.54	2.5/40.0	3900	895	107	20	42	V	1/3	1075
	UHH-290	224,000	22.4	4.45	2.5/40.0	4300	990	108	21	46	V	1/2	1075
UHH-340	273,000	27.3	3.24	2.5/50.0	5130	945	109	22	50	V	1/2	1075	

Table 4. Hot Water (Reduced Motor Speed)

Model Type UHH	Unit Size	Btu/Hr.	WATER DATA			AIR DATA						MOTOR DATA	
			GPM	Pressure Drop (Ft. of water)	Cfm	Outlet Velocity FPM	Final Air Temp. (°F)	Max. Mounting Height (ft.)*	Heat Spread@ Max Height*	Sound Class**	HP	Approx. RPM	
HORIZONTAL AIR DELIVERY	UHH-18	10,660	1.3	0.49	310	390	92	9	13	I	1/30	1200	
	UHH-24	14,186	1.7	0.83	350	450	98	10	14	I	1/30	1200	
	UHH-33	20,090	2.5	0.12	490	390	98	11	16	I	1/15	1200	
	UHH-47	27,716	3.4	0.21	565	455	105	13	18	II	1/15	1200	
	UHH-63	38,130	4.7	0.47	870	460	101	15	21	II	1/10	1200	
	UHH-86	50,758	6.2	0.79	1040	550	105	16	22	II	1/10	1200	
	UHH-108	66,420	8.1	0.85	1240	485	110	16	23	II	1/8	875	
	UHH-121	73,800	9.0	1.04	1415	555	108	17	26	II	1/8	875	
	UHH-165	109,060	13.3	2.48	1990	590	111	18	27	III	1/4	875	
	UHH-193	127,920	15.6	3.35	2310	680	111	19	28	III	1/4	875	

**Notes:**

1. Performance Data at Standard Conditions of 200°F Entering Water, 60°F Entering Air and 20°F Water Temperature Drop.
- \* Units with horizontal louvers open 30° from vertical plane.
- \*\* See page 12 for Sound Class definitions.

# Performance Data

## Horizontal Air Delivery Model UHH (Steam)

Table 5. Steam (High Motor Speed)

Model Type UHH	Unit Size	Btu/Hr.	Condensate lb./hr.	Sq. Ft. EDR	AIR DATA						MOTOR DATA	
					Cfm	Outlet Velocity FPM	Final Air Temp. (°F)	Max. Mounting Height (ft.)*	Heat Spread@ Max Height*	Sound Class**	HP	Approx. RPM
HORIZONTAL AIR DELIVERY	UHH-18	18,000	18	75	400	510	102	9	17	II	1/30	1550
	UHH-24	24,000	25	100	450	580	109	9	18	II	1/30	1550
	UHH-33	33,000	35	138	630	510	109	10	20	II	1/15	1550
	UHH-47	47,000	49	196	730	600	120	12	25	III	1/15	1550
	UHH-63	63,000	66	263	1120	605	112	14	29	III	1/10	1550
	UHH-86	86,000	89	358	1340	730	119	15	31	III	1/10	1550
	UHH-108	108,000	111	450	1550	625	125	15	32	III	1/8	1075
	UHH-121	121,000	126	504	1775	715	123	16	33	III	1/8	1075
	UHH-165	165,000	170	688	2500	750	121	17	34	IV	1/4	1075
	UHH-193	193,000	200	804	2900	870	122	18	37	IV	1/4	1075
	UHH-258	258,000	267	1075	3900	920	121	19	40	V	1/3	1075
UHH-290	290,000	300	1208	4300	1010	122	20	44	V	1/2	1100	
UHH-340	340,000	352	1417	5130	965	121	20	46	V	1/2	1100	

Table 6. Steam (Reduced Motor Speed)

Model Type UHH	Unit Size	Btu/Hr.	Condensate lb./hr.	Sq. Ft. EDR	AIR DATA						MOTOR DATA	
					Cfm	Outlet Velocity FPM	Final Air Temp. (°F)	Max. Mounting Height (ft.)*	Heat Spread@ Max Height*	Sound Class**	HP	Approx. RPM
HORIZONTAL AIR DELIVERY	UHH-18	14,800	15	62	310	395	104	9	12	I	1/30	1200
	UHH-24	19,700	21	82	350	455	112	9	13	I	1/30	1200
	UHH-33	27,100	29	113	490	395	111	10	14	I	1/15	1200
	UHH-47	38,500	40	161	565	465	123	12	18	II	1/15	1200
	UHH-63	51,700	54	216	870	470	115	14	21	II	1/10	1200
	UHH-86	70,500	73	294	1040	570	123	15	22	II	1/10	1200
	UHH-108	88,600	91	369	1240	500	126	15	23	II	1/8	875
	UHH-121	99,200	103	413	1415	570	125	16	23	II	1/8	875
	UHH-165	135,300	139	564	1990	600	123	17	24	III	1/4	875
	UHH-193	158,300	164	659	2310	695	123	18	26	III	1/4	875

**Notes:**

1. Performance Data at Standard Conditions of 2 lb. Steam and 60°F Entering Air.

\* Units with horizontal louvers open 30° from vertical plane.

\*\* See page 12 for Sound Class definitions.



# Performance Data

## Horizontal Air Delivery Model UHH

Table 7. Motor Data

Unit Size	Motor HP	VOLTAGE, MOTOR TYPE AND POWER CODE			
		115/60/1	230/60/1	230/460/60/3	115/208-230/60/1
		Totally Enclosed w/ Thermal Overload	Totally Enclosed w/ Thermal Overload	Totally Enclosed	Explosion Proof w/ Thermal Overload
		A	G	I	V
		Amps	Amps	Amps	Amps
UHH-18	1/30	0.70	0.22	N/A	4.8/2.3-2.4
UHH-24	1/30	0.70	0.22	N/A	4.8/2.3-2.4
UHH-33	1/15	0.72	0.50	N/A	4.8/2.3-2.4
UHH-47	1/15	0.72	0.50	N/A	4.8/2.3-2.4
UHH-63	1/10	1.30	0.59	1.4/0.7	4.8/2.3-2.4
UHH-86	1/10	1.30	0.59	1.4/0.7	4.8/2.3-2.4
UHH-108	1/8	1.58	0.80	2.2/1.1	6.8/3.1-3.4
UHH-121	1/8	1.58	0.80	2.2/1.1	6.8/3.1-3.4
UHH-165	1/4	2.65	1.40	2.2/1.1	6.8/3.1-3.4
UHH-193	1/4	2.75	1.40	2.2/1.1	6.8/3.1-3.4
UHH-258	1/3	3.60	2.00	2.2/1.1	7.8/3.6-3.9
UHH-290	1/2	4.68	2.20	2.2/1.1	9.6/4.7-4.8
UHH-340	1/2	4.68	2.20	2.2/1.1	9.6/4.7-4.8

**Power Code A:** Motors are 115 volt, 60 Hertz, single phase, totally enclosed with built-in thermal overload protection and a permanent split capacitor to minimize current draw.

**Power Code G:** Motors are 230 volt, 60 Hertz, single phase, totally enclosed with built-in thermal overload protection and a permanent split capacitor to minimize current draw.

**Power Code I:** Motors are 230/460 volt, 60 Hertz, three phase, totally enclosed polyphase induction type.

**Power Code V:** Motors are 115/208-230 volt, 60 Hertz, single phase, explosion-proof, totally enclosed with built-in thermal overload protection split phase type.

**Explosion proof motors** are suitable for Class I, Group C & D; Class II, Groups F & G; Class III. Canadian Standard Association (CSA) requirements state that the explosion proof units may not be used with a fluid temperature in excess of 329°F or pressures greater than 87 psig and still maintain their explosion proof rating for National Electric Code ignition temperature rating T3B for grain dust. Class I, Group D Motors are for operations in areas containing gasoline, petroleum, naphtha, benzene, butane, propane, alcohol, acetone, lacquer solvent or natural gas. Class II, Group F motors are for operations in areas containing carbon black, coal or coke dust. Class II, Group G motors are for operations in areas containing flour, starch or grain dust. Class III motors are for operations in areas containing easily ignitable fibers and flyings.

# Performance Data

## Vertical Air Delivery Model UDH

Table 8. Hot Water (High Motor Speed)

Model Type UDH	Unit Size	Btu/Hr.	WATER DATA			AIR DATA							MOTOR DATA		
			GPM	Pressure Drop (Ft. of water)	Min./Max GPM	Cfm	Outlet Velocity FPM	Final Air Temp. (°F)	Max. Mounting Height (ft.)*	Heat Spread@ Max Height*	Sound Class**	HP	Approx. RPM		
VERTICAL AIR DELIVERY	UDH-42	30,500	3.1	0.09	0.5/10.0	950	776	91	11	<b>15</b>	17	<b>11</b>	II	1/10	1550
	UDH-59	44,300	4.5	0.18	0.8/15.0	1150	940	97	14	<b>19</b>	21	<b>15</b>	II	1/10	1550
	UDH-78	58,500	6.0	0.43	1.0/20.0	1550	990	96	15	<b>21</b>	23	<b>16</b>	II	1/6	1550
	UDH-95	71,000	7.2	0.61	1.3/25.0	1775	1132	99	17	<b>23</b>	25	<b>17</b>	II	1/6	1550
	UDH-139	111,000	11.3	0.84	1.0/30.0	2500	1281	103	18	<b>25</b>	28	<b>19</b>	III	1/4	1075
	UDH-161	128,800	13.1	1.11	1.3/40.0	2900	1488	103	22	<b>30</b>	33	<b>21</b>	III	1/4	1075
	UDH-193	142,700	14.5	0.81	1.5/50.0	3900	1640	95	24	<b>33</b>	36	<b>24</b>	IV	1/2	900
	UDH-212	159,000	16.1	0.98	2.0/60.0	4300	1809	96	25	<b>35</b>	37	<b>25</b>	IV	1/2	1075
	UDH-247	197,000	19.9	1.65	2.0/60.0	5130	1803	97	27	<b>36</b>	40	<b>27</b>	IV	5/8	900
	UDH-279	220,000	22.2	2.01	2.3/75.0	5800	2037	97	31	<b>39</b>	47	<b>31</b>	V	5/8	1075
	UDH-333	265,000	26.7	1.27	2.8/75.0	6600	1966	99	30	<b>38</b>	46	<b>30</b>	V	1	1075
	UDH-385	308,000	31.1	1.68	3.3/75.0	7860	1928	97	33	<b>40</b>	49	<b>33</b>	VI	1	1140
UDH-500	403,000	40.9	2.32	3.0/100.0	10790	2487	94	40	<b>48</b>	60	<b>40</b>	VI	1-1/2	1140	
UDH-610	459,000	46.3	2.42	6.0/100.0	12350	2343	97	39	<b>47</b>	58	<b>40</b>	VI	1-1/2	1140	

**Notes:**

- Performance Data at Standard Conditions of 200°F Entering Water, 60°F Entering Air and 20°F Water Temperature Drop.
- \* Equipped with cone jet deflector, blades fully opened are shown in bold.  
Non-bolded mounting height/spread data is for units without deflectors. Please see page 31 for additional outlet accessory performance data.
- \*\* See page 12 for Sound Class definitions.

Table 9. Steam (High Motor Speed)

Model Type UDH	Unit Size	Btu/Hr.	Condensate lb./hr.	Sq. Ft. EDR	AIR DATA							MOTOR DATA		
					Cfm	Outlet Velocity FPM	Final Air Temp. (°F)	Max. Mounting Height (ft.)*	Heat Spread@ Max Height*	Sound Class**	HP	Approx. RPM		
VERTICAL AIR DELIVERY	UDH-42	42,000	43	175	950	779	103	11	<b>15</b>	17	<b>11</b>	II	1/10	1550
	UDH-59	59,000	61	246	1150	943	111	13	<b>18</b>	20	<b>13</b>	II	1/10	1550
	UDH-78	78,000	81	325	1550	992	110	14	<b>19</b>	22	<b>14</b>	II	1/6	1550
	UDH-95	95,000	99	396	1775	1136	113	16	<b>21</b>	24	<b>16</b>	II	1/6	1550
	UDH-139	139,000	144	579	2500	1284	116	18	<b>24</b>	27	<b>18</b>	III	1/4	1075
	UDH-161	161,000	167	671	2900	1490	115	21	<b>28</b>	31	<b>21</b>	III	1/4	1075
	UDH-193	193,000	200	804	3900	1643	109	23	<b>31</b>	34	<b>23</b>	IV	1/2	900
	UDH-212	212,000	219	883	4300	1812	109	25	<b>33</b>	37	<b>25</b>	IV	1/2	1075
	UDH-247	247,000	256	1029	5130	1805	107	26	<b>34</b>	39	<b>26</b>	IV	5/8	900
	UDH-279	279,000	288	1163	5800	2040	107	30	<b>37</b>	45	<b>30</b>	V	5/8	1075
	UDH-333	333,000	345	1388	6600	1968	110	30	<b>37</b>	45	<b>30</b>	V	1	1075
	UDH-385	385,000	398	1604	7860	1930	106	30	<b>36</b>	45	<b>30</b>	VI	1	1140
UDH-500	500,000	518	2083	10790	2490	103	37	<b>44</b>	56	<b>37</b>	VI	1-1/2	1140	
UDH-610	610,000	631	2542	12350	2345	106	36	<b>43</b>	54	<b>36</b>	VI	1-1/2	1140	

**Notes:**

- Performance Data at Standard Conditions of 2 lb. Steam and 60°F Entering Air - High Motor Speed
- \* Equipped with cone jet deflector, blades fully opened are shown in bold.  
Non-bolded mounting height/spread data is for units without deflectors. Please see page 31 for additional outlet accessory performance data.
- \*\* See page 12 for Sound Class definitions.

# Performance Data

## Vertical Air Delivery Model UDH

Table 10. Motor Data

Unit Size	Motor HP	VOLTAGE, MOTOR TYPE AND POWER CODE			
		115/60/1	230/60/1	230/460/60/3	115/208-230/60/1
		Totally Enclosed w/ Thermal Overload	Totally Enclosed w/ Thermal Overload	Totally Enclosed	Explosion Proof w/ Thermal Overload
		A	G	I	V
		Amps	Amps	Amps	Amps
UDH-42	1/10	1.30	0.59	1.4/0.7	4.8/2.3-2.4
UDH-59	1/10	1.30	0.59	1.4/0.7	4.8/2.3-2.4
UDH-78	1/6	2.20	1.10	1.4/0.7	4.8/2.3-2.4
UDH-95	1/6	2.20	1.10	1.4/0.7	4.8/2.3-2.4
UDH-139	1/4	2.75	1.40	2.2/1.1	6.6/3.1-3.3
UDH-161	1/4	2.75	1.40	2.2/1.1	6.6/3.1-3.3
UDH-193	1/2	4.68	2.20	2.2/1.1	9.6/4.7-4.8
UDH-212	1/2	4.68	2.20	2.2/1.1	9.6/4.7-4.8
UDH-247	5/8	5.85	3.40	4.2/2.1	9.6/4.7-4.8
UDH-279	5/8	5.85	3.40	4.2/2.1	9.6/4.7-4.8
UDH-333	1	8.95	4.50	4.2/2.1	—
UDH-385	1	—	—	4.2/2.1	—
UDH-500	1-1/2	—	—	5.0/2.5	—
UDH-610	1-1/2	—	—	5.0/2.5	—

**Power Code A:** Motors are 115 volt, 60 Hertz, single phase, totally enclosed with built-in thermal overload protection and a permanent split capacitor to minimize current draw.

**Power Code G:** Motors are 230 volt, 60 Hertz, single phase, totally enclosed with built-in thermal overload protection and a permanent split capacitor to minimize current draw.

**Power Code I:** Motors are 230/460 volt, 60 Hertz, three phase, totally enclosed polyphase induction type.

**Power Code V:** Motors are 115/208-230 volt, 60 Hertz, single phase, explosion-proof, totally enclosed with built-in thermal overload protection split phase type.

**Explosion proof motors** are suitable for Class I, Group C & D; Class II, Groups F & G; Class III. Canadian Standard Association (CSA) requirements state that the explosion proof units may not be used with a fluid temperature in excess of 329°F or pressures greater than 87 psig and still maintain their explosion proof rating for National Electric Code ignition temperature rating T3B for grain dust. Class I, Group D Motors are for operations in areas containing gasoline, petroleum, naphtha, benzene, butane, propane, alcohol, acetone, lacquer solvent or natural gas. Class II, Group F motors are for operations in areas containing carbon black, coal or coke dust. Class II, Group G motors are for operations in areas containing flour, starch or grain dust. Class III motors are for operations in areas containing easily ignitable fibers and flyings.

# Application Guidelines

**Application Guidelines for heat loss calculations should reference the ASHRAE Guide or other recognized HVAC engineering publication (or other authoritative source). Essential engineering data should include design conditions for the following:**

- BTU requirements
- CFM
- Final air temperature
- Steam or hot water applications
- Building type (architectural special needs, if any)
- Location and spacing of units
- Mounting heights
- Heat throw or air diffusion
- Sound classifications

## Horizontal Delivery Unit Heaters

Characterized by its horizontal air delivery, this unit heater is widely used for general industrial and commercial heating. Horizontally positioned louvers (standard) attached to the air-discharge side of the unit can be adjusted to lengthen or shorten heat throw and/or decrease or increase the mounting height. Adjustable vertical louvers (optional) when used in combination with horizontal louvers permit complete directional control of heated air.

## Vertical Delivery Unit Heaters

Due to their directly downward air discharge, vertical units are particularly desirable for heating areas with high ceilings and where crane ways and other obstructions dictate higher mounting of heating equipment. Four air distribution devices providing distinctively different heat-throw patterns are offered to meet specific heat-throw and heat-spread requirements (see Vertical Air Outlet Options page 30).

## Other Factors Which Can Influence Selection

Where it is necessary to mount units low, select models with lower cfm ratings as the greater volumes of air handled by larger units can create excessive air movement when mounted low. Better air distribution and economy of heating-system operation is realized when a greater number of smaller unit heaters are used instead of a fewer number of larger units. Sound ratings of certain models may limit their use for certain applications. In such instances, select units by size such that the total number of units meet the heat loss and sound criteria. Canadian Standards Association (CSA) requirements state that explosion-proof units may not be used with a fluid temperature in excess of 329°F or 87 psi and still maintain their explosion-proof rating.

## Selection for Applications Where Sound is a Factor

Wherever fans and motors are used to move air, sound is generated. Such, of course, is the case with unit heaters. Sound emissions of a certain large unit heater model may limit its use in applications where sound level requirements may be critical. In such instances, smaller models should be selected which in total meet the heat-load criteria of a larger single unit heater. Cfm and velocity (fpm) ratings are generally indicative of sound levels, i.e., the higher the cfm and velocity rating of a unit heater, the greater the sound emissions from the unit.

## Sound Classification:

McQuay Unit Heaters are designed to minimize sound created by airflow and motor operation by careful component selection and inlet geometry. The Sound Classification list below shows typical rooms and their corresponding sound class rating. When placed in the paired room, the unit's sound level should be relatively comparable to the ambient sound level.

## Building or Room Sound Zones

<b>Type of Building or Room Sound Zone</b>	<b>Sound Zone</b>
Apartments, Class Rooms, Court Rooms, Executive Offices, Hospitals, Libraries, Museums, Residences.....	I
General Offices, Hotel Dining Rooms, Private Offices, Recreation Rooms, Show Rooms, Small Stores, Tea Rooms, Upper Floors at Department Stores .....	II
Bank Lobbies, Cafeterias, Drug Stores, General Offices, Grocery Stores, Gymnasiums, Main Floors at Department Stores, Public Buildings, Post Offices, Restaurants, Service Stations.....	III
Factories, Foundries, Garages, Machine Shops, Office Machinery Rooms, Packing Plants, Shipping Platforms, Steel Mills, Stadium Common Areas .....	II-VII
Boiler Works, Forge Shops, Round Houses, Steel Fabricating Shops.....	VII

# Application Guidelines

---

## Locating Unit Heaters

1. Always direct airflow to regions of greatest heat loss.
2. More, smaller units will provide better heat distribution than fewer larger units.
3. The number of units used depends on the heat throw or heat spread of the individual heaters. Arrange unit heaters to minimize piping costs.
4. More than any other single factor, improper mounting height is responsible for most unsatisfactory unit heater installations. When heaters are mounted higher than recommended, improper heat distribution is the result and comfort is reduced.
  - Mount units at the lowest practical and allowable level.
  - Watch final air temperature on units mounted at lower levels or in heavily occupied areas to ensure that air is warm enough to avoid noticeable drafts.
5. It is advisable to locate unit heaters so that their air streams are subjected to a minimum of interference from columns, machinery, partitions and other obstacles.
6. Unit heaters installed in a building exposed to a prevailing wind should be located so as to direct a large portion of the heated air along the windward side of the building.
7. Horizontal delivery unit heaters should be located so that the air streams of the individual units wipe the exposed walls of the building with either parallel flow or angular flow without blowing directly against the walls. Heaters should be spaced so that each supports the air stream from another heater. This sets up a circulatory air movement which produces a blanket of warm air along the cold wall.
8. Horizontal units should be arranged so they do not blow directly at workers. Their air streams should be directed down aisles, into open spaces on the floor, or along exterior walls of the building.
10. Large expanses of glass or large doors that are frequently opened should be covered by long-throw unit heaters such as large horizontal delivery unit heaters.
11. In buildings having high ceilings, vertical delivery unit heaters equipped with the correct air-distribution devices are recommended to produce comfort in central areas of the same building.
12. When only vertical delivery heaters are used, they should be located so that exposed walls are blanketed with the warm air they deliver.
13. Several unit heaters may be operated by a single thermostat. In large open spaces where various activities are carried on, zonal heating will improve comfort and generally reduce fuel costs. Unit heaters may also be controlled individually, either manually or by a thermostat.
14. Unit heater fans may be operated during warm weather to maintain air circulation. If this is desired, units should be equipped with fan switches when they are installed.
15. **Illustrations appearing on page 14 & 15 suggest various spacing and arrangements of unit heaters for providing adequate heating coverage.** Proper placement of unit heaters in a space to be heated will also simplify piping and reduce installation costs.

# Application Guidelines

## Monitor-Type Building

This application utilizes both **horizontal** and **vertical** delivery unit heaters. Vertical units located in the central high-ceiling area clear the crane way below them. Horizontal units are used in the low-ceiling areas.

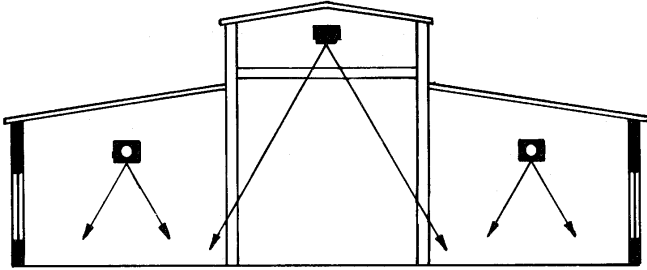

## Warehouse Building

This typical application of **horizontal** unit heaters illustrates the maximum heat coverage with a minimum number of units.

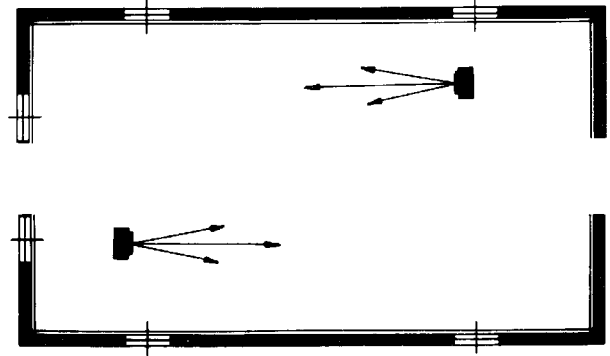

## Mill Type Building

Here each **horizontal** delivery unit heater supports the air stream from another to set up a circulatory air movement within the space to be heated. This arrangement illustrates the basic principle of unit heater location.

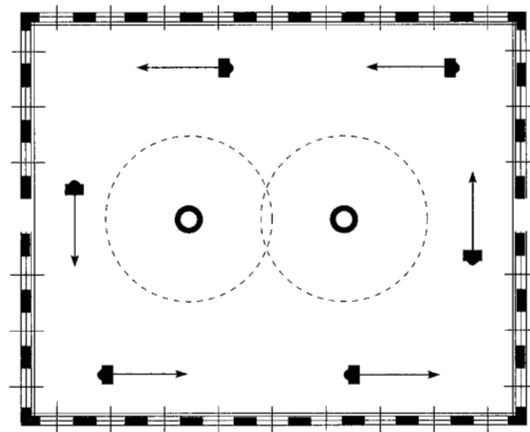
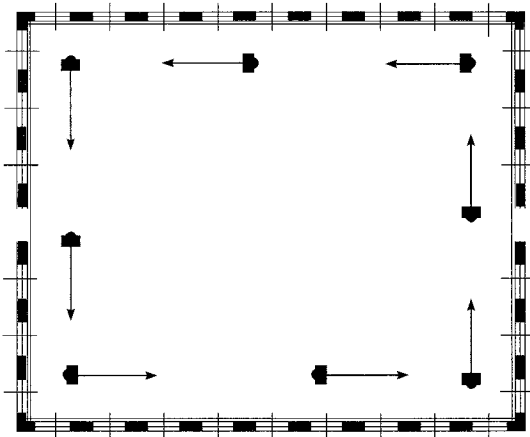

## Office/Manufacturing Building

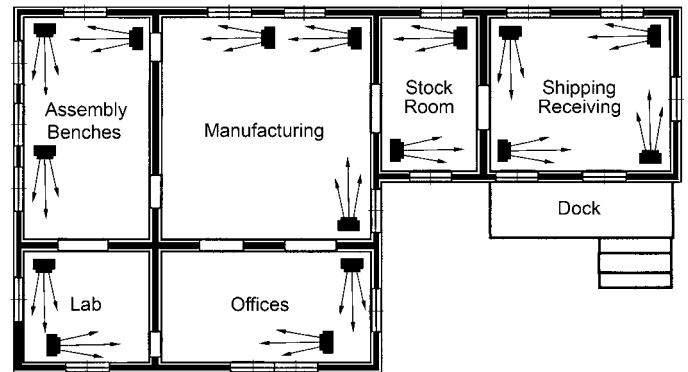

## Narrow Building

Heat spread from **vertical** units supplies good coverage of the entire floor space and blankets walls with warmed air.

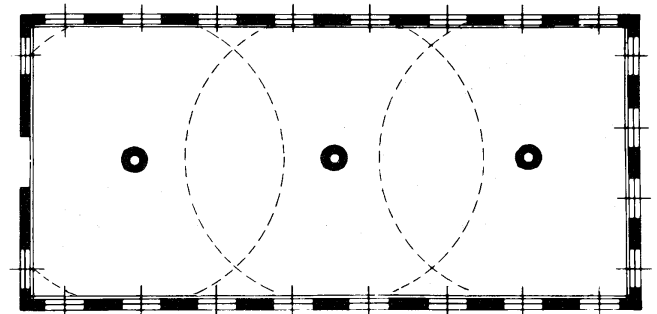

# Application Guidelines

---

## Automatic Control

### Control Sequences

The following control sequence descriptions are commonplace for steam/hot water horizontal and vertical air delivery unit heaters.

### Continuous Fan Operation - Intermittent Hot/Cold

**Coil** - A room thermostat controls a valve which opens to allow steam or hot water to supply the unit and closes to shut off the supply when the thermostat is satisfied. The fan runs continuously.

**Intermittent Fan Operation - Hot Coil** - A room thermostat starts and stops the motor when a thermostat calls for heat, the motor is energized. An aquastat is sometimes strapped to the supply or return piping to prevent fan operation when heat is not being supplied to the unit heater. The heating fluid is continuously supplied to the unit heater even with the motor off. After thermostat is satisfied, motor is de-energized.

### Intermittent Fan Operation - Intermittent

**Hot/Cold Coil** - To prevent a unit heater from delivering cold air when the thermostat is “calling for” heat, an aquastat prevents fan operation when the heat supply to the coil is interrupted. Conversely, the aquastat energizes the fan when the automatic supply valve opens to allow the heating medium to enter the unit heater coil.

## Energy Saver – Optional Control

An “Energy Star” control used with vertical air delivery unit heaters can automatically deliver warm stratified air to the zone of occupancy, minimize ceiling heat loss and overall energy consumption. Two thermostats and an auxiliary switch are required for one or more unit heaters, plus a two-position supply valve for each unit heater. The room thermostat controls the two-position supply valve to each unit heater. An auxiliary fan switch stops the unit heater fan when the supply valve is closed. The other thermostat (“Energy Saver” Control) is located near the vertical unit heater at the ceiling or roof where warm air tends to stratify.

The room thermostat will automatically signal the supply valve to close when its setting has been “satisfied.” However, the thermostat mounted near the unit heater can override the auxiliary switch to allow the unit heater fan to run with the supply valve closed, until the temperature at the higher level falls below the set-point of the higher mounted thermostat.

Additionally, air delivered by a vertical unit heater located in high ambient temperatures prevalent at the upper levels within a building is excessively buoyant and frequently prevents the unit heater fan from delivering the heated air to the occupancy level of the building. By recycling the heat which builds up at these higher levels, the two-thermostat control arrangement contributes to increased comfort and lower heating costs.

# Selection Formulas & Data

## Example 1: Hot Water Calculation, Horizontal Unit

### Given Design Conditions:

Horizontal Air Delivery Requested

Heating load: 120,000 Btu/hr.

Entering Water Temperature: 180°F

Entering Air Temperature (EAT<sub>A</sub>): 50°F

### Application Procedure

#### I. Unit Selection

Table 12 (page 18)  
Hot Water Conversion Factor = 0.940

$$\begin{aligned} \text{Btus} &= \frac{\text{Btu}_A}{\text{Hot Water Conversion Factor}} = \\ &= \frac{120,000}{0.940} = \end{aligned}$$

**Btus = 127,660** with Rated Capacity of 133,000 Btu/HR. at Standard Conditions

#### II. Actual Heating Capacity

$$\text{Btu}_A = 133,000 \times 0.940 = \mathbf{125,020 \text{ Btu/HR.}}$$

$$\text{Btu}_A = \text{Btus} \times \text{Heating Capacity Factor}$$

#### III. Final Air Temperature

Table 2 (page 6) Model UHH-165 CFMs = 2500

$$\begin{aligned} \text{FAT}_A &= \text{EAT}_A + \left[ \frac{(460 + \text{EAT}_A)}{576} \times \frac{\text{Btu}_A}{\text{CFMs}} \right] \\ &= 50 + \left[ \frac{(460 + 50)}{576} \times \frac{125,020}{2500} \right] \\ &= 50 + [8854 \times 50.0] \\ \mathbf{\text{FAT}_A} &= \mathbf{50 + 44.27 = \text{FAT}_A = 94^\circ\text{F}} \end{aligned}$$

#### IV. Water Temperature Drop

Table 2 (page 6) GPM = 13.3

$$\text{WTD}_A = \left( \frac{\text{Btu}_A}{500 \times \text{GPM}_A} \right)$$

$$\text{WTD}_A = \frac{125,020}{500 \times 13.3} =$$

$$\mathbf{\text{WTD}_A = 19.5^\circ\text{F}}$$

#### V. Maximum Mounting Height

Table 2 (page 6) Standard Mounting Height = 18 ft.  
Table 11 (page 16)  
Mounting Height Correction Factor = 1.08

$$\begin{aligned} \text{MMH}_A &= \text{MMH}_S \times \text{Correction Factor} = \\ &= 18 \times 1.08 \\ \mathbf{\text{MMH}_A} &= \mathbf{19.4 \text{ ft.}} \end{aligned}$$

**Table 11. Hot Water Unit Heater Mounting Height Correction Factors**

	WATER TEMPERATURE DROP, (°F)																
	140	150	160	170	180	190	200	210	220	230	240	250	260	270	280	290	300
Correction Factor	1.33	1.25	1.19	1.13	1.08	1.04	1.00	0.97	0.94	0.91	0.89	0.86	0.84	0.82	0.80	0.78	0.77

#### Note:

Factors are for use with entering air temperature ranging from 50°F to 70°F.



# Selection Formulas & Data

## Hot Water Calculation Formulas

### 1. Table 12 (page 18)

To determine the heating capacity (Btu/hr.) of a unit heater at a water temperature and/or entering air temperature other than standard conditions of 200°F entering water temperature, 60°F entering air temperature.

To find actual unit heater capacity when operating at non-standard (actual) conditions:

$$\mathbf{Btu_A = Btu_S \times \text{Heating Capacity Factor}}$$

To select a heater capacity based on standard conditions to meet a heating capacity at non-standard (actual) conditions:

$$\mathbf{Btu_S = Btu_A / \text{Heating Capacity Factor}}$$

### 2. Table 13 (page 18)

To determine how water temperature drop affects heat capacity in Btu, water flow rate is in GPM and pressure drop in feet of water. These factors should be applied to the values at actual entering water and air temperature conditions.

To find actual unit heater capacity or flow rate or pressure drop when operating at non-standard (actual) conditions:

$$\mathbf{Btu_A = Btu_S \times \text{Btu Correction Factor}}$$

$$\mathbf{GPM_A = GPM_S \times \text{GPM Correction Factor}}$$

$$\mathbf{WPD_A = WPD_S \times \text{WPD Correction Factor}}$$

To select a heater capacity based on standard conditions to meet a heating capacity at non-standard (actual) conditions:

$$\mathbf{Btu_S = Btu_A \div \text{Btu Correction Factor}}$$

### 3. Table 14 (page 18)

To determine how glycol solutions affect heater capacity. These factors should be applied to the heater capacity at actual entering water and air temperature conditions.

To find actual unit heater capacity when operated with glycol solution:

$$\mathbf{Btu_{AG} = Btu_S \text{ (or } Btu_A) \times \text{Glycol Correction Factor}}$$

To select a heater capacity based on standard conditions to meet a heating capacity with glycol solution:

$$\mathbf{Btu_S \text{ (or } Btu_A) = Btu_{AG} \div \text{Glycol Correction Factor}}$$

### 4. Table 11 (page 16)

To determine how water temperatures other than 200°F affect mounting height of unit.

$$\mathbf{\text{Max. Mounting Height}_A = \text{Max. Mounting Height}_S \times \text{Correction Factor}}$$

## Other Useful Formulas

### Horizontal Unit Heaters (UHH):

$$\mathbf{FAT_A = EAT_A + \left[ \frac{(460 + EAT_A)}{576} \times \frac{Btu_A}{CFM_S} \right]}$$

### Vertical Unit Heaters (UDH):

$$\mathbf{FAT_A = EAT_A + \left[ \frac{(460 + EAT_A)}{\left( \frac{576 \times CFM_S}{Btu_A} \right) - 1} \right]}$$

$$\mathbf{WTD_A = \left( \frac{Btu_A}{500 \times GPM_A} \right)}$$

## Terminology:

- Btu<sub>A</sub>** = Capacity at non-standard (actual) conditions
- Btu<sub>AG</sub>** = Capacity with Glycol solution.
- Btu<sub>S</sub>** = Capacity at standard conditions (200°F entering water temperature, 60°F entering air temperature) from Tables 2 and 3 on page 6 (UHH) and Table 8 on page 10 (UDH).
- Cfm<sub>S</sub>** = Unit airflow as found in Tables 2 and 3 on page 6 (UHH) and Table 8 on page 10 (UDH).
- EAT<sub>A</sub>** = Entering air temperature at actual conditions
- FAT<sub>A</sub>** = Final air temperature at actual conditions
- GPM<sub>A</sub>** = Water flow rate at actual conditions in GPM
- GPM<sub>S</sub>** = Flow rate at standard conditions (200°F entering water temperature, 60°F entering air temperature) from Tables 2 and 3 on page 6 (UHH) and Table 8 on page 10 (UDH).
- WPD<sub>A</sub>** = Water pressure drop at non-standard (actual) conditions.
- WPD<sub>S</sub>** = Water pressure drop at standard conditions (200°F entering water temperature, 60°F entering air temperature) from Tables 2 and 3 on page 6 (UHH) and Table 8 on page 10 (UDH).

# Selection Formulas & Data

**Table 12 – Hot Water Heating Capacity Conversion Factors**

Entering Water Temp. (°F)	Entering Air Temperature, (°F)										
	0	10	20	30	40	50	60	70	80	90	100
100	0.769	0.683	0.599	0.518	0.439	0.361	0.286	0.212	0.140	0.069	0.000
110	0.846	0.759	0.674	0.592	0.512	0.434	0.357	0.283	0.210	0.138	0.068
120	0.923	0.835	0.749	0.666	0.585	0.506	0.429	0.353	0.279	0.207	0.137
130	1.000	0.911	0.824	0.740	0.658	0.578	0.500	0.424	0.349	0.276	0.205
140	1.077	0.987	0.899	0.814	0.731	0.651	0.571	0.494	0.419	0.345	0.273
150	1.154	1.063	0.974	0.888	0.805	0.723	0.643	0.565	0.489	0.414	0.342
160	1.231	1.139	1.049	0.962	0.878	0.795	0.714	0.636	0.559	0.483	0.410
170	1.308	1.215	1.124	1.036	0.950	0.867	0.786	0.706	0.629	0.552	0.478
180	1.385	1.291	1.199	1.110	1.024	0.940	0.857	0.777	0.699	0.621	0.547
190	1.492	1.367	1.274	1.184	1.097	1.012	0.929	0.848	0.768	0.690	0.615
200	1.539	1.443	1.349	1.258	1.170	1.084	1.000	0.918	0.838	0.759	0.684
210	1.615	1.519	1.424	1.332	1.243	1.157	1.071	0.989	0.908	0.828	0.752
220	1.962	1.594	1.499	1.406	1.312	1.229	1.143	1.060	0.978	0.897	0.820
230	1.769	1.670	1.573	1.480	1.390	1.301	1.241	1.130	1.048	0.966	0.889
240	1.846	1.746	1.649	1.554	1.463	1.373	1.286	1.201	1.118	1.035	0.957
250	1.923	1.822	1.723	1.628	1.536	1.446	1.357	1.272	1.188	1.104	1.025
260	2.000	1.898	1.798	1.702	1.609	1.518	1.429	1.342	1.257	1.173	1.094
270	2.077	1.974	1.873	1.776	1.682	1.590	1.500	1.413	1.327	1.242	1.162
280	2.154	2.050	1.948	1.850	1.755	1.663	1.571	1.483	1.397	1.311	1.230
290	2.231	2.126	2.023	1.924	1.829	1.734	1.643	1.554	1.467	1.380	1.300
300	2.308	2.202	2.098	1.998	1.902	1.807	1.714	1.625	1.537	1.449	1.367

**Table 13. Correction Factors for Varying Water Temperature Drop (See Note)**

USE FACTORS FROM THIS TABLE TO OBTAIN APPROXIMATE RESULTS	ENTERING WATER TEMPERATURE, °F											
		10	15	20	25	30	35	40	45	50	55	60
To obtain Btu for other Water Temperature Drops, multiply basic Btu rating by applicable Factor.	1.23	1.13	1.06	1.00	0.95	0.90	0.86	0.82	0.78	0.72	0.69	0.67
To obtain GPM for other Water Temperature Drops, multiply basic GPM rating by applicable Factor.	4.64	2.21	1.40	1.00	0.76	0.61	0.50	0.42	0.36	0.30	0.26	0.23
To obtain Pressure Loss Feet of Water for other Temperature Drops, multiply Basic Loss at 20° drop by Factor.	17.24	4.32	1.85	1.00	0.61	0.41	0.30	0.22	0.18	0.14	0.12	0.11

**Note:** Water temperature drop correction factors valid only for standard 200°F entering water and 60°F air temperature conditions.

**Table 14. Ethylene Glycol Correction Factors**

Solution Temperature (°F)	ETHYLENE GLYCOL SOLUTION %						
	20%	30%	40%	50%	60%	70%	80%
100	0.99	0.96	0.93	0.89	0.85	0.81	0.76
150	0.99	0.96	0.94	0.90	0.87	0.83	0.78
200	0.99	0.97	0.94	0.92	0.88	0.85	0.81
250	0.98	0.96	0.94	0.92	0.89	0.86	0.82

**Note:** For Propylene Glycol solution correction factor, multiply Ethylene Glycol correction factor by 0.95.

# Selection Formulas & Data

## Example 2: Steam Calculation, Horizontal Unit

### Given Design Conditions:

Unit Heater Model: UHH-63  
 Steam Pressure: 10 lbs.  
 Entering Air Temperature (EAT<sub>A</sub>): 70°F

### Application Procedure

**I. Capacity - at standard conditions**      2 lbs. Steam, 60° Entering Air (EAT<sub>s</sub>).      **Table 4 (page 7) Btus = 63,000 Btu/HR.**

**Capacity - at non-standard conditions**      **Table 15 (page 20) Heating Capacity Factor = 1.06**  
 10 lbs. Steam, 70° Entering Air (EAT<sub>A</sub>).      Btu<sub>A</sub> = Btus × Heating Capacity Factor = 63,000 × 1.06 = **Btu<sub>A</sub> = 66,780 Btu/HR.**

Method A

**II. Final Air Temperature**      **Table 4 (page 7) FAT<sub>s</sub> = 112°F**  
 Air Temp Rise Calculations      ATR<sub>A</sub> = (FAT<sub>s</sub> - EAT<sub>s</sub>) × Air Temp Rise Factor (**Table 21-1.**) = (112°F - 60°F) × 1.07 = **ATR<sub>A</sub> = 55.64°F**

FAT<sub>A</sub> Calculations      FAT<sub>A</sub> = (EAT<sub>A</sub> + ATR<sub>A</sub>) = 70°F + 55.64°F = **FAT<sub>A</sub> = 125.64°F**

Method B

**II. Final Air Temperature**      **Table 4 (page 7) CFM = 1120**  
 FAT<sub>A</sub> Calculations  

$$FAT_A = \frac{(Btu_A)}{1.085 \times CFM} + EAT_A = \frac{66,780}{1.085 \times 1120} + 70°F = 55°F + 70°F = \mathbf{FAT_A = 125°F}$$
 (Compared to 125.64°F in Method A)

**III. Condensate - at standard conditions**      **Table 4 (page 7) Standard Conditions = 66 LB./HR.**

Condensate (A)      **Table 17 (page 21) Latent Heat of Steam = 952.5**  

$$\text{Condensate} = \frac{Btu_A}{\text{Latent Heat of Steam}} = \frac{66,780}{952.5} = \mathbf{70.11 LB./HR.}$$

Condensate (B):  

$$\frac{Btu_A}{240} = \text{EDR} \left( \begin{array}{c} \text{Equivalent Direct} \\ \text{Radiation} \end{array} \right) = \frac{66,780}{240} = 278.5$$

$$\text{Condensate} = \frac{\text{EDR}}{4} = \frac{278.5}{4} = \mathbf{69.56 LB./HR.}$$

**IV. Final Air Volume - at standard conditions**      **Table 4 (page 7) Final Air Temp. FAT<sub>s</sub> = 112°F, Nominal Cfm = 1120**  
 2 lbs. steam, 60°F Entering Air (EAT<sub>s</sub>)  

$$\mathbf{Final AV} = \left( \frac{460 + FAT_s}{530} \right) \times Cfm = \left( \frac{460 + 112}{530} \right) \times 1120 = 1.08 \times 1120 = \mathbf{1210 Cfm}$$

**V. Final Air Volume**  
 10 lbs. steam, 70°F Entering Air (EAT<sub>A</sub>)  

$$\mathbf{Final AV} = \left( \frac{460 + FAT_A}{530} \right) \times Cfm = \left( \frac{460 + 125.64}{530} \right) \times 1120 = 1.10 \times 1120 = \mathbf{1232 Cfm}$$

**VI. Maximum Mounting Height**      **Table 4 (page 7) Max. Mounting Height = 14 ft.**  
                                                                  **Table 18 (page 21) Mounting Height Correction Factor = 0.94**  
                                                                  MMH<sub>A</sub> = MMH<sub>s</sub> × Correction Factor = 14 × 0.94 = **MMH<sub>A</sub> = 13.16 ft.**

# Selection Formulas & Data

## Steam Calculation Formulas

### 1. Table 15

To determine the heating capacity (Btu/hr.) of a unit heater at a steam pressure and/or entering air temperature other than standard conditions of 2 lb. Steam and 60°F entering air temperature.

To find actual unit heater capacity when operating at non-standard (actual) conditions:

$$\mathbf{Btu_A = Btu_S \times Heating\ Capacity\ Factor}$$

To select a heater capacity based on standard conditions to meet a heating capacity at non-standard (actual) conditions:

$$\mathbf{Btu_S = Btu_A \div Heating\ Capacity\ Factor}$$

### 2. Table 16 (page 21)

To determine the air temperature rise of a unit heater at a steam pressure and/or entering air temperature other than standard conditions of 2 lb. Steam, 60°F entering air temperature.

To find actual air temperature rise of unit heater when operating at non-standard (actual) conditions:

$$\mathbf{ATR_A = (FAT_S - EAT_S) \times Air\ Temperature\ Rise\ Factor}$$

To find actual final air temperature of unit heater when operating at non-standard (actual) conditions:

$$\mathbf{FAT_A = EAT_A + ATR_A}$$

### 3. Table 18 (page 21)

To determine how non-standard steam pressures (other than 2 lb.) affect mounting height.

$$\mathbf{Max.\ Mounting\ Height_A = Max.\ Mounting\ Height_S \times Correction\ Factor}$$

### 4. Table 17 (page 21)

To determine the rate of condensate production at steam pressures other than 2 lb.

$$\mathbf{Condensate\ Rate = Btu_A \div Latent\ Heat\ of\ Steam}$$

### 5. $Btu \div 240 = EDR$ (Equivalent Direct Radiation)

### 6. $EDR \div 4 = LBS./HR.$ Condensate

$$\mathbf{7. ATR_A = \left( \frac{Btu_A}{Cfm \times 1.085} \right)}$$

## Terminology

**ATR<sub>A</sub>** = Air temperature rise at non-standard (actual) conditions

**Btu<sub>A</sub>** = Capacity at actual operating conditions

**Btu<sub>S</sub>** = Capacity at standard conditions (2 lb. Steam, 60°F entering air temperature) from Tables 4 and 5 on page 7

**EAT<sub>A</sub>** = Entering air temperature at non-standard (actual) conditions

**EAT<sub>S</sub>** = Entering air temperature at standard conditions (60°F)

**FAT<sub>A</sub>** = Final air temperature at non-standard (actual) conditions

**FAT<sub>S</sub>** = Final air temperature at standard conditions from Tables 4 and 5 on page 7

**Max. Mounting Height<sub>A</sub>** = Maximum mounting height at actual conditions

**Max. Mounting Height<sub>S</sub>** = Maximum mounting height at standard conditions

**Table 15. - Steam Heating Capacity Conversion Factors, Horizontal Delivery**

Model UHH	Entering Air Temp. (°F)	STEAM PRESSURE (PSIG)																
		0	2	5	10	15	20	30	40	50	60	70	75	80	90	100	125	150
HORIZONTAL DELIVERY	-10	1.54	1.59	1.64	1.73	1.80	1.86	1.97	2.06	2.13	2.20	2.26	2.28	2.31	2.36	2.41	2.51	2.60
	0	1.45	1.50	1.55	1.64	1.71	1.77	1.87	1.96	2.04	2.09	2.16	2.18	2.21	2.26	2.31	2.41	2.50
	10	1.37	1.41	1.46	1.55	1.61	1.68	1.78	1.86	1.94	2.00	2.06	2.09	2.11	2.16	2.20	2.31	2.40
	20	1.27	1.32	1.37	1.46	1.53	1.58	1.68	1.77	1.85	1.90	1.96	1.99	2.02	2.06	2.11	2.21	2.30
	30	1.19	1.24	1.29	1.38	1.44	1.50	1.60	1.68	1.76	1.81	1.87	1.90	1.93	1.97	2.02	2.11	2.20
	40	1.11	1.16	1.21	1.29	1.34	1.42	1.51	1.60	1.67	1.73	1.78	1.81	1.84	1.88	1.93	2.02	2.11
	50	1.03	1.08	1.13	1.21	1.28	1.33	1.43	1.51	1.58	1.64	1.70	1.72	1.75	1.79	1.84	1.93	2.02
	60	0.96	1.00	1.05	1.13	1.19	1.25	1.35	1.43	1.50	1.56	1.61	1.64	1.66	1.71	1.75	1.84	1.93
	70	0.88	0.93	0.97	1.06	1.12	1.17	1.27	1.35	1.42	1.47	1.53	1.55	1.58	1.62	1.66	1.76	1.84
	80	0.81	0.85	0.90	0.98	1.04	1.10	1.19	1.27	1.34	1.39	1.45	1.47	1.50	1.54	1.58	1.68	1.76
	90	0.74	0.78	0.83	0.91	0.97	1.02	1.12	1.19	1.26	1.31	1.37	1.40	1.42	1.46	1.50	1.59	1.67
100	0.67	0.71	0.76	0.84	0.90	0.95	1.04	1.12	1.19	1.24	1.29	1.32	1.34	1.38	1.42	1.51	1.59	

# Selection Formulas & Data

## Steam Application

Table 16. - Air Temperature Rise Conversion Factors, Horizontal Delivery

Model UHH	Entering Air Temp. (°F)	STEAM PRESSURE (PSIG)																
		0	2	5	10	15	20	30	40	50	60	70	75	80	90	100	125	150
HORIZONTAL DELIVERY	-10	1.33	1.38	1.43	1.50	1.56	1.61	1.70	1.78	1.84	1.91	1.95	1.97	2.00	2.04	2.08	2.17	2.25
	0	1.28	1.33	1.38	1.45	1.51	1.56	1.65	1.73	1.79	1.86	1.91	1.93	1.95	2.00	2.04	2.13	2.21
	10	1.24	1.27	1.33	1.40	1.46	1.52	1.60	1.68	1.74	1.81	1.86	1.89	1.91	1.95	1.99	2.09	2.17
	20	1.17	1.22	1.27	1.35	1.42	1.46	1.55	1.62	1.69	1.75	1.81	1.84	1.86	1.90	1.95	2.04	2.12
	30	1.12	1.17	1.21	1.29	1.36	1.41	1.51	1.58	1.65	1.71	1.76	1.79	1.82	1.86	1.89	1.99	2.07
	40	1.07	1.11	1.16	1.24	1.10	1.36	1.46	1.54	1.60	1.66	1.71	1.74	1.76	1.81	1.85	1.94	2.03
	50	1.01	1.06	1.11	1.19	1.24	1.30	1.40	1.48	1.55	1.61	1.66	1.69	1.72	1.75	1.79	1.89	1.98
	60	0.96	1.00	1.05	1.13	1.19	1.25	1.35	1.43	1.50	1.56	1.61	1.64	1.66	1.70	1.75	1.84	1.93
	70	0.90	0.94	1.00	1.07	1.14	1.19	1.29	1.38	1.45	1.50	1.56	1.58	1.61	1.65	1.69	1.79	1.87
	80	0.84	0.88	0.93	1.02	1.08	1.14	1.24	1.32	1.39	1.45	1.51	1.53	1.56	1.60	1.64	1.74	1.83
	90	0.78	0.83	0.88	0.95	1.02	1.08	1.18	1.26	1.33	1.40	1.45	1.47	1.49	1.54	1.59	1.68	1.77
100	0.72	0.76	0.82	0.90	0.97	1.02	1.12	1.21	1.28	1.33	1.39	1.42	1.44	1.49	1.53	1.63	1.71	

Table 17. - Properties of Steam

Gauge Pressure (PSIG)	Temp (°F)	Latent Heat (Btu/lb.)	Gauge Pressure (PSIG)	Temp. (°F)	Latent Heat (Btu/lb.)	Gauge Pressure (PSIG)	Temp. (°F)	Latent Heat (Btu/lb.)	Gauge Pressure (PSIG)	Temp. (°F)	Latent Heat (Btu/lb.)
0	212.0	970.3	34	279.4	924.7	70	316.0	897.3	109	343.6	875.4
2	218.5	966.2	36	281.9	922.9	72	317.7	896.0	112	345.4	873.9
4	224.4	962.4	38	284.3	921.1	74	319.3	894.8	115	347.2	872.5
5	227.2	960.6	40	286.7	919.3	76	320.9	893.5	118	348.9	871.0
6	229.8	958.8	42	289.0	917.6	78	322.4	892.3	121	350.7	869.6
8	234.8	955.6	44	291.3	915.9	80	323.9	891.1	124	352.4	868.2
10	239.4	952.5	46	293.5	914.3	82	325.4	889.9	125	352.9	867.8
12	243.7	949.6	48	295.6	912.7	84	326.9	888.8	127	354.0	866.9
14	247.8	946.8	50	297.7	911.2	86	328.4	887.6	130	355.7	865.5
16	251.6	944.2	52	299.7	909.7	88	329.8	886.5	133	357.3	864.1
18	255.3	941.7	54	301.7	908.2	90	331.2	885.4	136	358.9	862.9
20	258.8	939.3	56	303.6	906.7	92	332.5	884.3	139	360.4	861.5
22	262.1	936.9	58	305.5	905.3	94	333.9	883.2	142	362.0	860.3
24	265.3	934.7	60	307.3	903.9	96	335.2	882.1	145	363.5	859.0
26	268.3	932.5	62	309.1	902.5	98	336.6	881.1	150	365.9	856.9
28	271.3	930.5	64	310.9	901.2	100	337.9	880.0	175	377.4	846.8
30	274.1	928.5	66	312.6	899.9	103	339.8	878.5	200	387.9	837.2
32	276.8	926.6	68	314.4	898.6	106	341.7	876.9	225	397.3	828.5

Table 18. - Steam Unit Heater Mounting Height Correction Factors

Steam Pressure (PSIG)	2	5	10	15	20	30	40	50	60	70	80	90	100	125	150	175
Correction Factor	1.00	0.97	0.94	0.92	0.89	0.86	0.84	0.82	0.80	0.79	0.77	0.76	0.75	0.74	0.72	0.71

# Selection Formulas & Data

---

## Example 3: Hot Water Calculation, Vertical Unit

### Water Design Conditions:

Vertical Model UDH-059 Given Hot Water Design Conditions  
 Entering Water Temperature: 250°F  
 Entering Air Temperature (EAT<sub>A</sub>): 70°F

### Application Procedure

---

**I. Capacity - at standard conditions** **Table 8 (page 10) = 44,300**  
 200°F Entering Water Temperature, **Btus = 44,300 Btu/HR.**  
 60°F Entering Air, 20°F Water Temperature Drop

---

**Capacity - at non-standard conditions** **Table 12 (page 18) Water Capacity Conversion = 1.272**  
 250°F Entering Water Temperature Btu<sub>A</sub> = Btus × Heating Capacity Factor  
 70°F Entering Air (EAT<sub>A</sub>) Btu<sub>A</sub> = 44,300 × 1.272 = **Btu/HR. = 56,350**

---

**II. A. Water Flow Rate (GPM)** **Table 8 (page 10) GPM = 4.5**

---

**B. GPM - at other TD's** **Table 12 (page 18) For GPM Correction Factor**  
 (Not 20°F TD) 

$$\left( \begin{array}{c} \text{Table 8} \\ \text{Standard} \end{array} \right) \times \left( \begin{array}{c} \text{Table 12} \\ \text{Correction} \end{array} \right)$$

---

**III. Final Air Temperature**

**Table 8 (page 10) GPM = 4.5 or Calculated GPM (see procedure II-B.)**

$$FAT_A = EAT_A + \left[ \left( \frac{460 + EAT_A}{\frac{576 \times CFM_S}{Btu_A}} - 1 \right) \right] = 70 + \left[ \left( \frac{460 + 70}{\frac{576 \times 1150}{56350}} - 1 \right) \right] = 70 + \left( \frac{530}{11.76 - 1.0} \right) = 70 + 49.26 = FAT_A = \mathbf{119.26^\circ F}$$

---

**IV. Water Temperature Drop**

$$WTD_A = \left( \frac{Btu_A}{500 \times GPM_A} \right) = \frac{56,350}{500 \times 4.5} = \mathbf{25.0^\circ F}$$

---

**V. Maximum Mounting Height**

**Table 8 (page 10) Standard Mounting Height = 14 ft.**  
**Table 11 (page 16) Mounting Height Correction Factor = 0.86**  
 MMH<sub>A</sub> = MMHs × Correction Factor = 14 × 0.86 = **MMH<sub>A</sub> = 12 ft.**

---

## Example 4: Steam Calculation, Vertical Unit

### Given Design Conditions:

Vertical Air Delivery Requested  
 Heating Load: 100,000 Btu/HR  
 Entering Air Temperature (EAT<sub>A</sub>): 50°F  
 Steam Pressure: 2 lbs.

### Application Procedure

---

**I. Unit Selection** **Table 19 (page 23) Heating Capacity Factor = 1.07**

$$Btus = \frac{Btu_A}{\text{Heating Capacity Factor}} = \frac{100,000}{1.07} = \mathbf{Btus = 93,458}$$

Reference Table 8 (page 10) UDH-95 will meet the heating requirements with rated capacity of 95,000 Btu/HR. at standard conditions (Btus)

---

**II. Actual Heating Capacity** **Btu<sub>A</sub> = Btus × Heating Capacity Factor = 95,000 × 1.07 = 101,650 Btu<sub>A</sub>**

---

# Selection Formulas & Data

## Model UDH Steam Application

Table 19. Steam Heating Capacity Conversion Factors, Vertical Delivery

Model UDH	Entering Air Temp. (°F)	STEAM PRESSURE (PSIG)																
		0	2	5	10	15	20	30	40	50	60	70	75	80	90	100	125	150
VERTICAL DELIVERY	-10	1.49	1.52	1.58	1.64	1.70	1.75	1.83	1.90	1.96	2.02	2.07	2.10	2.11	2.15	2.19	2.27	2.34
	0	1.41	1.45	1.50	1.57	1.62	1.67	1.75	1.82	1.87	1.94	1.99	2.02	2.04	2.08	2.11	2.19	2.26
	10	1.33	1.37	1.42	1.49	1.55	1.60	1.68	1.75	1.81	1.87	1.92	1.94	1.96	2.00	2.03	2.11	2.18
	20	1.25	1.29	1.34	1.41	1.47	1.52	1.61	1.68	1.74	1.79	1.84	1.86	1.88	1.92	1.95	1.99	2.10
	30	1.18	1.22	1.27	1.34	1.40	1.45	1.53	1.61	1.67	1.72	1.76	1.79	1.80	1.84	1.88	1.91	2.03
	40	1.11	1.15	1.20	1.27	1.32	1.37	1.46	1.53	1.59	1.64	1.69	1.71	1.73	1.77	1.80	1.88	1.95
	50	1.03	1.07	1.12	1.19	1.25	1.30	1.39	1.46	1.52	1.57	1.62	1.64	1.66	1.69	1.73	1.81	1.88
	60	0.96	1.00	1.05	1.12	1.18	1.23	1.32	1.39	1.45	1.50	1.55	1.57	1.59	1.62	1.66	1.74	1.81
	70	0.90	0.93	0.98	1.05	1.11	1.16	1.25	1.32	1.38	1.43	1.47	1.49	1.51	1.55	1.59	1.67	1.74
	80	0.83	0.86	0.91	0.98	1.04	1.09	1.18	1.25	1.31	1.36	1.40	1.42	1.44	1.48	1.52	1.60	1.67
	90	0.76	0.80	0.85	0.91	0.97	1.02	1.11	1.18	1.24	1.29	1.33	1.36	1.38	1.41	1.45	1.53	1.60
100	0.69	0.73	0.78	0.85	0.90	0.96	1.04	1.11	1.17	1.22	1.27	1.29	1.31	1.34	1.38	1.46	1.53	

Table 20. Air Temperature Rise Conversion Factors, Vertical Delivery

Model UDH	Entering Air Temp. (°F)	STEAM PRESSURE (PSIG)																
		0	2	5	10	15	20	30	40	50	60	70	75	80	90	100	125	150
VERTICAL DELIVERY	-10	1.36	1.41	1.46	1.54	1.61	1.67	1.77	1.85	1.92	1.99	2.05	2.08	2.10	2.15	2.19	2.29	2.39
	0	1.31	1.35	1.40	1.48	1.55	1.61	1.71	1.79	1.86	1.93	1.99	2.02	2.04	2.09	2.14	2.24	2.33
	10	1.25	1.29	1.35	1.43	1.49	1.55	1.65	1.74	1.81	1.88	1.94	1.96	1.99	2.04	2.08	2.18	2.27
	20	1.19	1.24	1.29	1.37	1.44	1.50	1.60	1.68	1.75	1.82	1.88	1.91	1.93	2.00	2.02	2.12	2.22
	30	1.13	1.18	1.23	1.31	1.38	1.44	1.54	1.62	1.69	1.76	1.82	1.85	1.87	1.92	1.97	2.07	2.16
	40	1.08	1.12	1.17	1.25	1.32	1.38	1.48	1.56	1.64	1.70	1.76	1.79	1.81	1.86	1.91	2.01	2.10
	50	1.02	1.06	1.12	1.20	1.26	1.32	1.42	1.51	1.58	1.65	1.70	1.73	1.75	1.80	1.85	1.95	2.04
	60	0.96	1.00	1.06	1.14	1.20	1.26	1.36	1.45	1.52	1.58	1.65	1.67	1.70	1.74	1.79	1.89	1.99
	70	0.90	0.94	1.00	1.08	1.14	1.20	1.30	1.39	1.46	1.53	1.59	1.62	1.64	1.69	1.73	1.83	1.93
	80	0.84	0.88	0.94	1.02	1.09	1.15	1.25	1.33	1.40	1.47	1.53	1.56	1.58	1.63	1.67	1.77	1.87
	90	0.78	0.82	0.88	0.96	1.02	1.08	1.18	1.27	1.34	1.41	1.47	1.50	1.52	1.57	1.61	1.71	1.81
100	0.72	0.76	0.82	0.89	0.97	1.02	1.12	1.21	1.28	1.35	1.41	1.43	1.46	1.51	1.55	1.65	1.75	

# Motor Data & Power Codes

Table 21. Motor Data

Model Type		Motor HP	VOLTAGE, MOTOR TYPE AND POWER CODE			
			115/60/1	230/60/1	230/460/60/3	115/208-230/60/1
			Totally Enclosed w/ Thermal Overload	Totally Enclosed w/ Thermal Overload	Totally Enclosed	Explosion Proof w/ Thermal Overload
			A	G	I	V
			Amps	Amps	Amps	Amps
Horizontal Model UHH	UHH-18	1/30	0.70	0.22	N/A	4.8/2.3-2.4
	UHH-24	1/30	0.70	0.22	N/A	4.8/2.3-2.4
	UHH-33	1/15	0.72	0.50	N/A	4.8/2.3-2.4
	UHH-47	1/15	0.72	0.50	N/A	4.8/2.3-2.4
	UHH-63	1/10	1.30	0.59	1.4/0.7	4.8/2.3-2.4
	UHH-86	1/10	1.30	0.59	1.4/0.7	4.8/2.3-2.4
	UHH-108	1/8	1.58	0.80	2.2/1.1	6.8/3.1-3.4
	UHH-121	1/8	1.58	0.80	2.2/1.1	6.8/3.1-3.4
	UHH-165	1/4	2.65	1.40	2.2/1.1	6.8/3.1-3.4
	UHH-193	1/4	2.75	1.40	2.2/1.1	6.8/3.1-3.4
	UHH-258	1/3	3.60	2.00	2.2/1.1	7.8/3.6-3.9
	UHH-290	1/2	4.68	2.20	2.2/1.1	9.6/4.7-4.8
UHH-340	1/2	4.68	2.20	2.2/1.1	9.6/4.7-4.8	
Vertical Model UDH	UDH-42	1/10	1.30	0.59	1.4/0.7	4.8/2.3-2.4
	UDH-59	1/10	1.30	0.59	1.4/0.7	4.8/2.3-2.4
	UDH-78	1/6	2.20	1.10	1.4/0.7	4.8/2.3-2.4
	UDH-95	1/6	2.20	1.10	1.4/0.7	4.8/2.3-2.4
	UDH-139	1/4	2.75	1.40	2.2/1.1	6.6/3.1-3.3
	UDH-161	1/4	2.75	1.40	2.2/1.1	6.6/3.1-3.3
	UDH-193	1/2	4.68	2.20	2.2/1.1	9.6/4.7-4.8
	UDH-212	1/2	4.68	2.20	2.2/1.1	9.6/4.7-4.8
	UDH-247	5/8	5.85	3.40	4.2/2.1	9.6/4.7-4.8
	UDH-279	5/8	5.85	3.40	4.2/2.1	9.6/4.7-4.8
	UDH-333	1	8.95	4.50	4.2/2.1	—
	UDH-385	1	—	—	4.2/2.1	—
	UDH-500	1-1/2	—	—	5.0/2.5	—
	UDH-610	1-1/2	—	—	5.0/2.5	—

**Power Code A:** Motors are 115 volt, 60 Hertz, single phase, totally enclosed with built-in thermal overload protection and a permanent split capacitor to minimize current draw.

**Power Code G:** Motors are 230 volt, 60 Hertz, single phase, totally enclosed with built-in thermal overload protection and a permanent split capacitor to minimize current draw.

**Power Code I:** Motors are 230/460 volt, 60 Hertz, three phase, totally enclosed polyphase induction type.

**Power Code V:** Motors are 115/208-230 volt, 60 Hertz, single phase, explosion-proof, totally enclosed with built-in thermal overload protection split phase type.

**Explosion proof motors** are suitable for Class I, Group C & D; Class II, Groups F & G; Class III. Canadian Standard Association (CSA) requirements state that the explosion proof units may not be used with a fluid temperature in excess of 329°F or pressures greater than 87 psig and still maintain their explosion proof rating for National Electric Code ignition temperature rating T3B for grain dust. Class I, Group D Motors are for operations in areas containing gasoline, petroleum, naphtha, benzene, butane, propane, alcohol, acetone, lacquer solvent or natural gas. Class II, Group F motors are for operations in areas containing carbon black, coal or coke dust. Class II, Group G motors are for operations in areas containing flour, starch or grain dust. Class III motors are for operations in areas containing easily ignitable fibers and flyings.



# Performance Curves – Horizontal Model UHH

200°F Entering Water Temperature / 60°F Entering Air Temperature

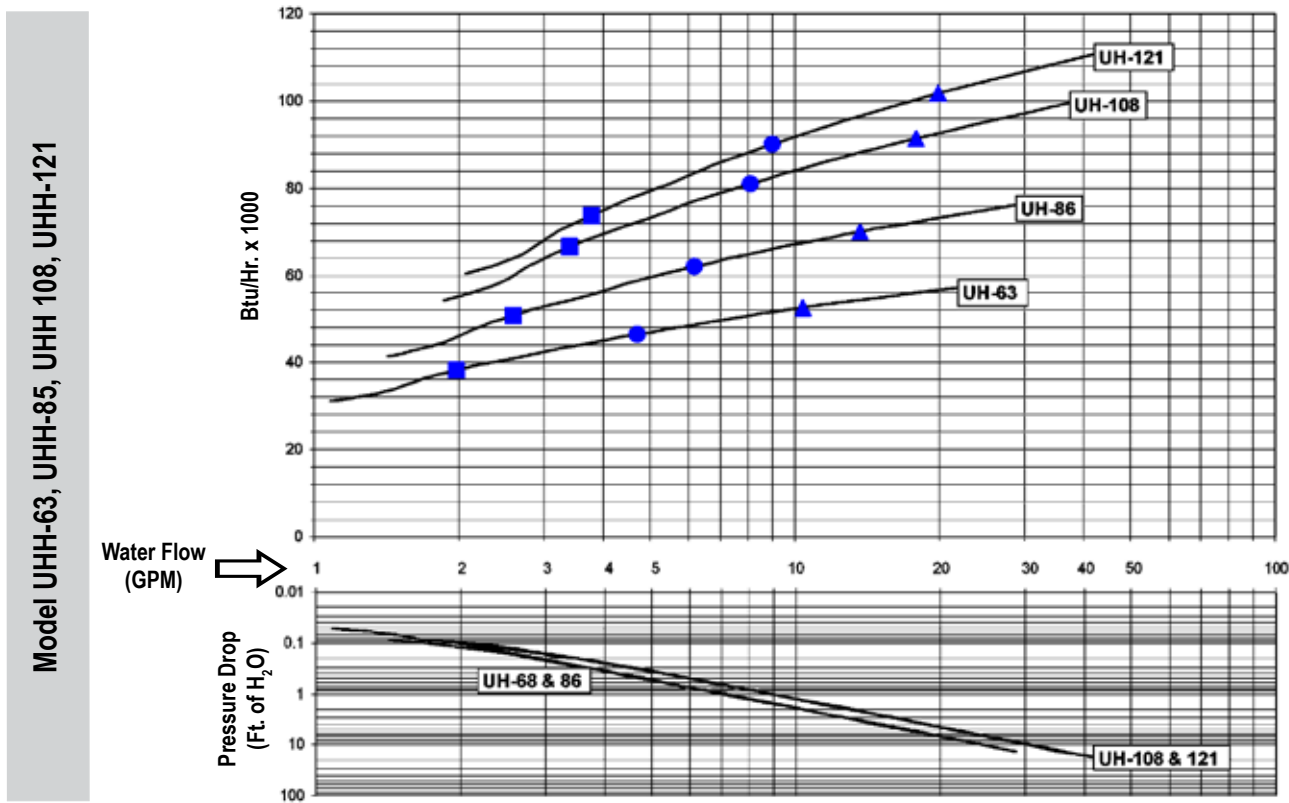
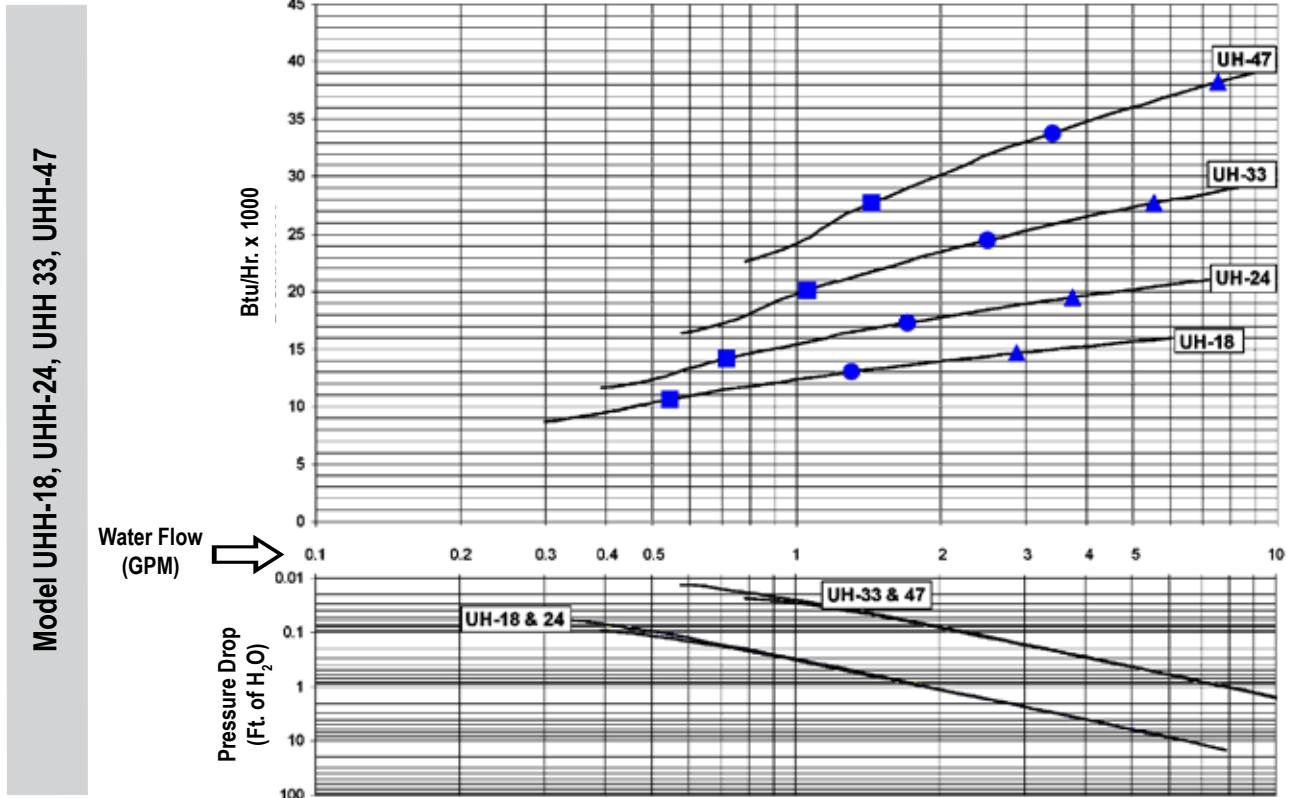

■ Indicates point of 40°F water temperature drop

● Indicates point of 20°F water temperature drop

▲ Indicates point of 10°F water temperature drop

# Performance Curves – Horizontal Model UHH

200°F Entering Water Temperature / 60°F Entering Air Temperature

Model UHH-165, UHH-193, UHH-258

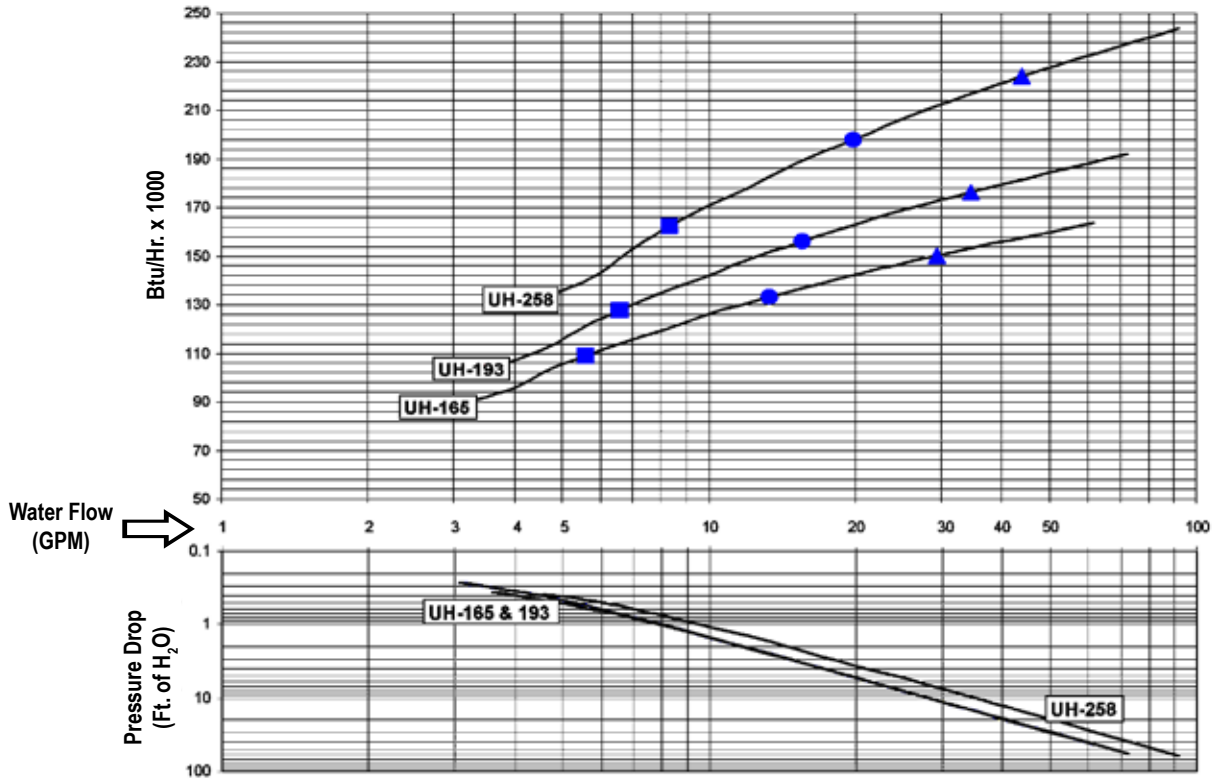

Model UHH-290, UHH-340

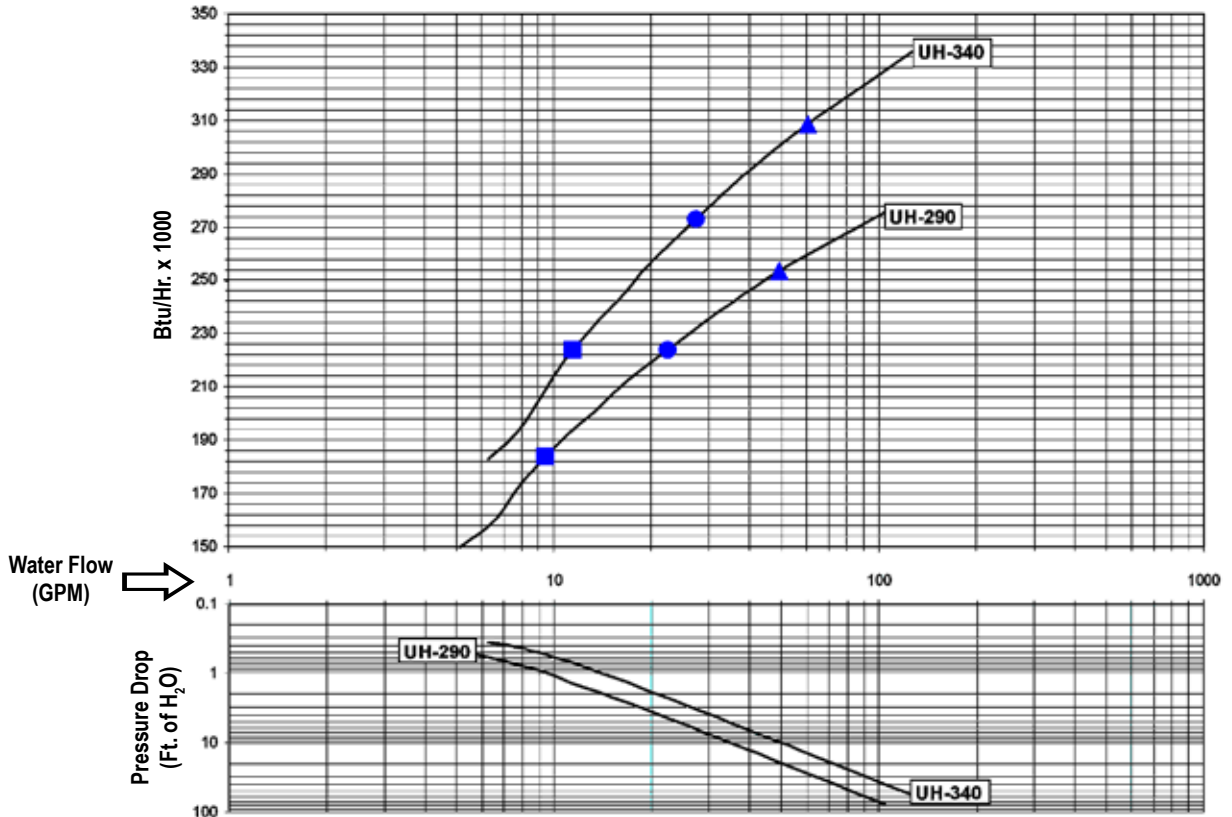

■ Indicates point of 40°F water temperature drop

● Indicates point of 20°F water temperature drop

▲ Indicates point of 10°F water temperature drop

# Performance Curves – Horizontal Model UDH

200°F Entering Water Temperature / 60°F Entering Air Temperature

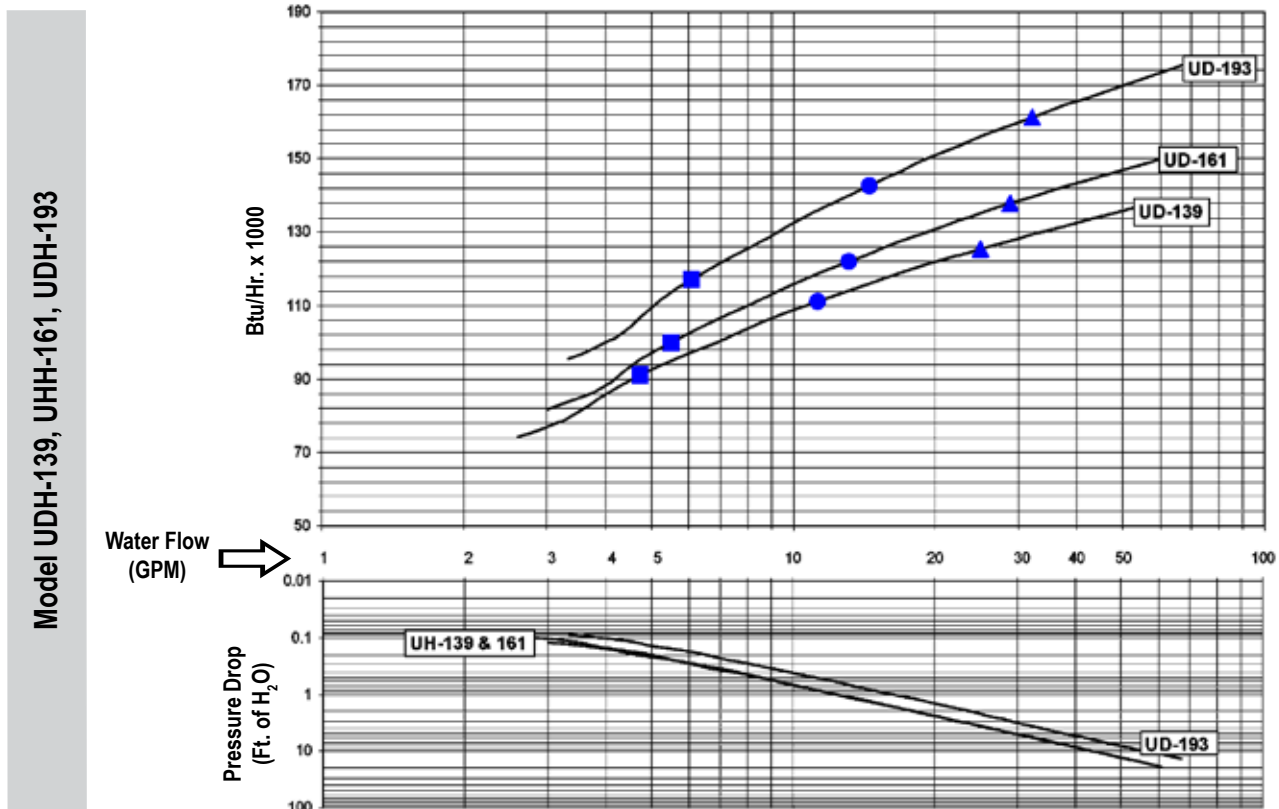
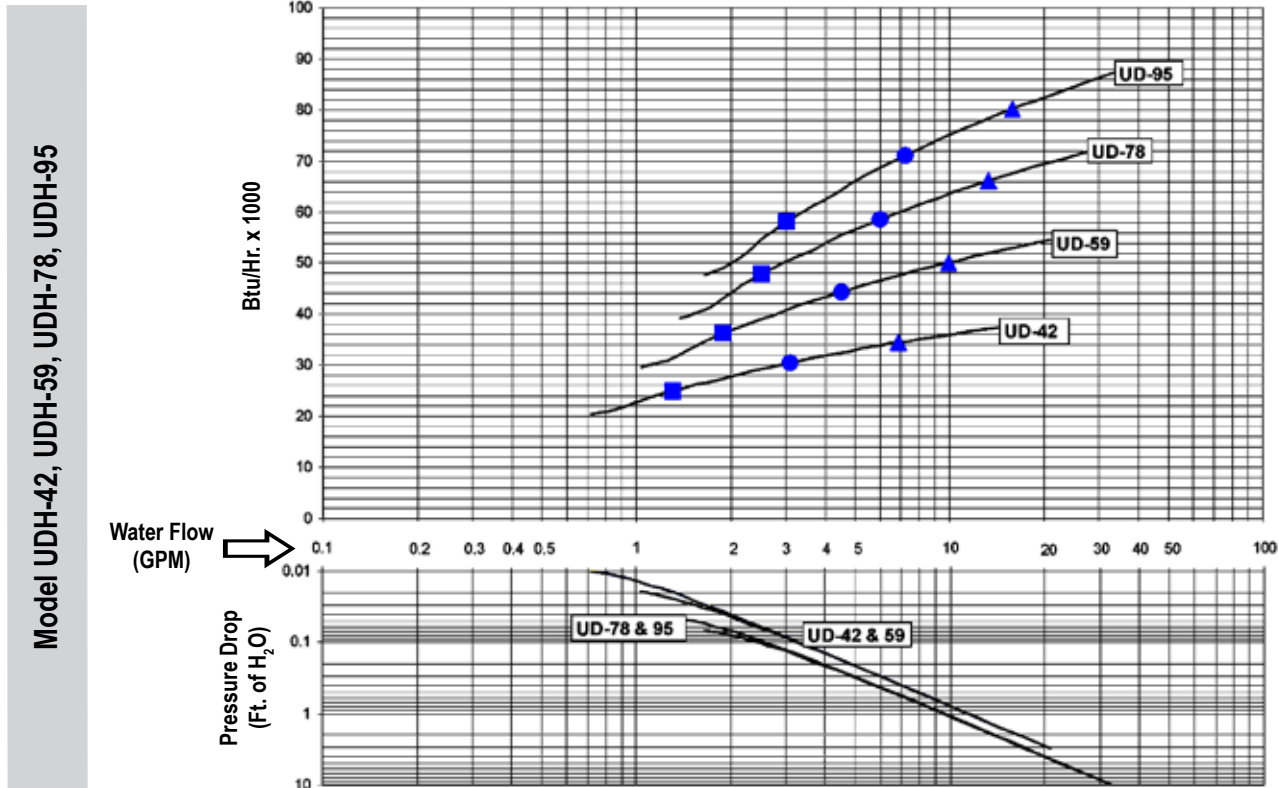

■ Indicates point of 40°F water temperature drop

● Indicates point of 20°F water temperature drop

▲ Indicates point of 10°F water temperature drop

# Performance Curves – Horizontal Model UDH

200°F Entering Water Temperature / 60°F Entering Air Temperature

Model UDH-212, UDH-247, UDH-279

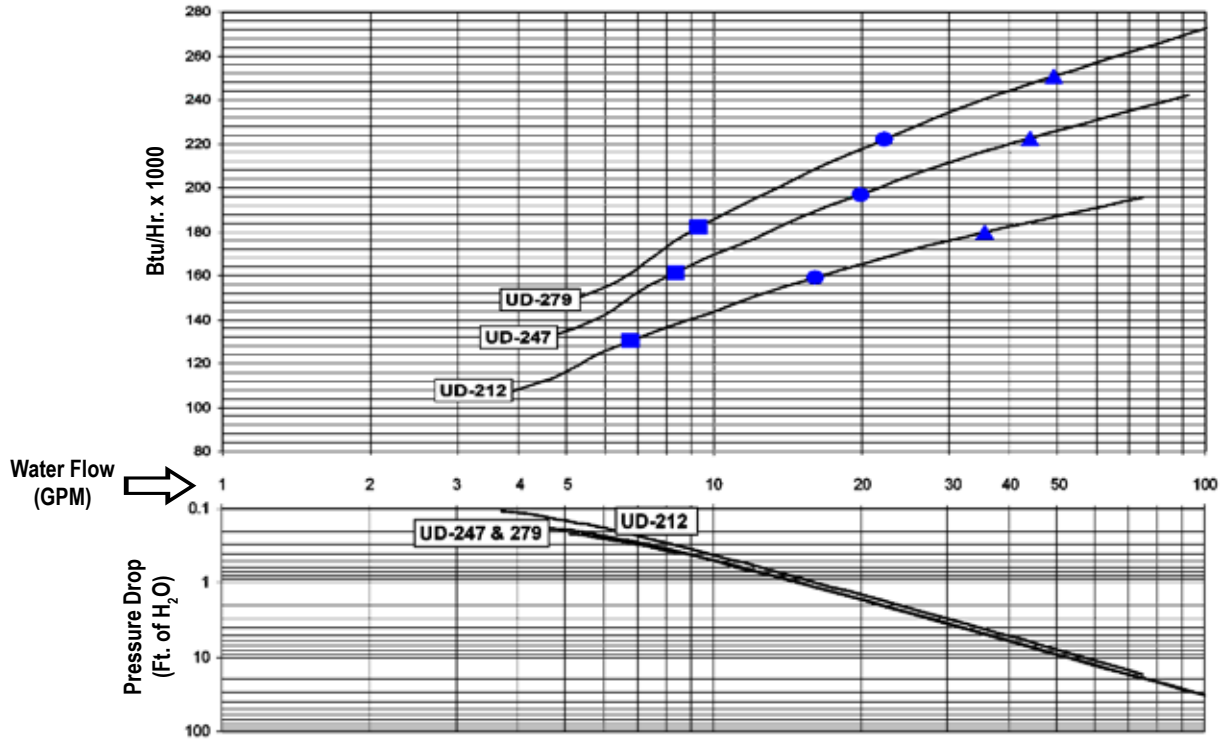

Model UDH-333, UHH-385, UDH-500, UDH-610

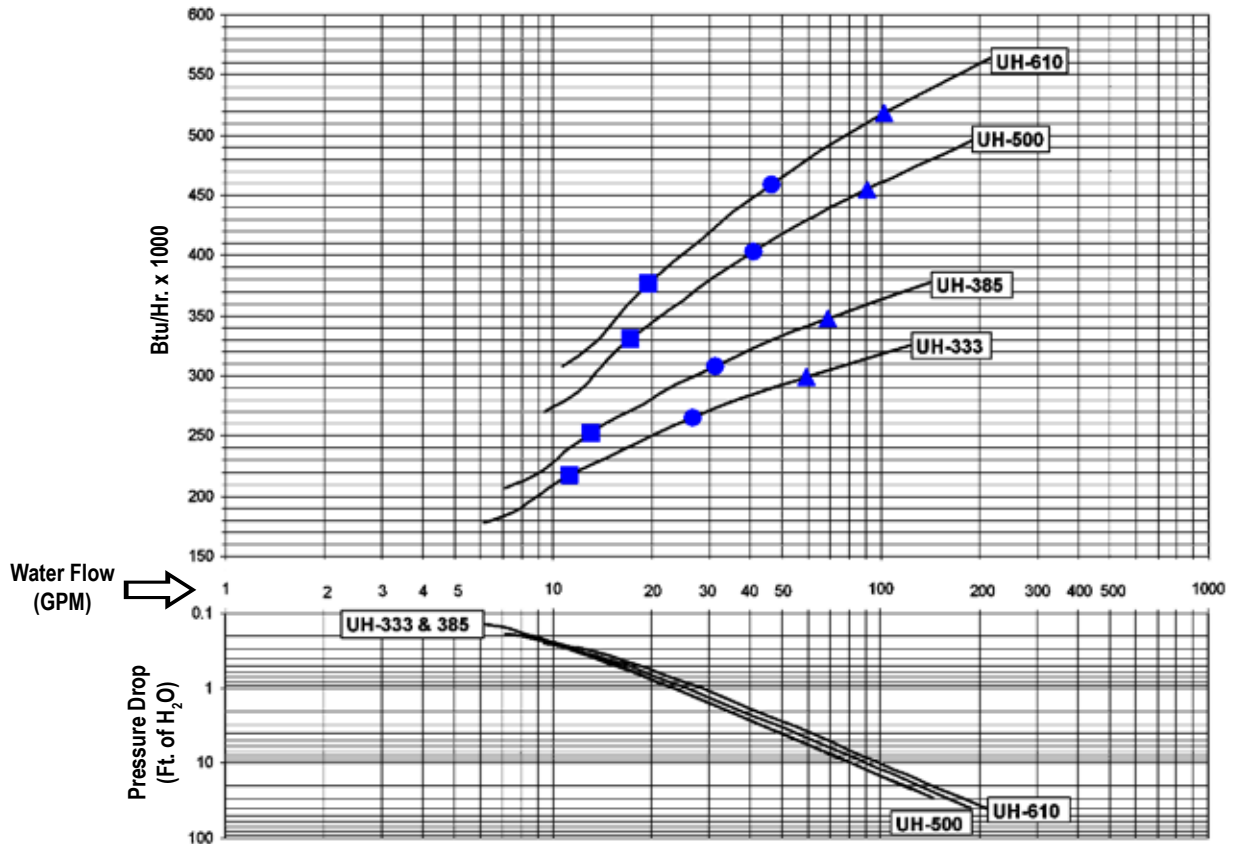

■ Indicates point of 40°F water temperature drop

● Indicates point of 20°F water temperature drop

▲ Indicates point of 10°F water temperature drop

# Options/Accessories

## Unit Heater Options

Factory Mounted Option	Description
<b>Disconnect</b>	Unit Mounted toggle switch for on/off control of fan operation, only for <b>Power Code A</b> .
<b>Speed Controller (Variable speed)</b>	Unit Mounted speed controller allows infinite adjustment of fan speed, controlling airflow volume, available only with <b>Power Code A</b> .
<b>Unit Mounted Thermostat</b>	Unit Mounted Thermostat turns fan on after air temperature falls below set point. Line Voltage Heating Thermostat Range 50°F to 90°F 25A @ 120V/240V, only for <b>Power Codes A and G</b> .
<b>Manual Starter</b>	Unit Mounted toggle switch starter with thermal overload protection for on/off fan control. Starter comes with a fused overload that protects unit up to 125% load, only for <b>Power Codes A and G</b> .
<b>Diffuser Blades</b>	Diffuser blades are attached to louver to deflect airflow in directions left or right of the heater.
<b>Note:</b> Contact factory for options requiring different voltages than listed above.	
Field Installed Options	Description
<b>Thermostat</b>	Line Voltage Heating Thermostat Range 50°F to 90°F 25A @ 120V/240V, only for <b>Power Codes A and G</b> .
<b>Explosion-Resistant Thermostat</b>	46°F to 84°F range 10.2A @ 115V, 6.5A @ 230V.
<b>Aquastat</b>	Surface Mounted Aquastat Range 100°F to 240°F. It will delay the motor until a predetermined water temperature is reached.
<b>Speed Controller (Variable speed)</b>	Wall Mounted speed controller allows remote infinite adjustment of fan speed, controlling airflow volume, available only with <b>Power Code A</b> .
<b>Thermostat Guard</b>	Clear plastic locking guard with lock and keys to deter unwanted adjustment of set temperature.
<b>Pipe Hanger Kit</b>	Allows unit to be suspended from ceiling by threaded pipe instead of threaded rod.
<b>Manual Starter</b>	Wall Mounted toggle switch starter with thermal overload protection for remote on/off control of fan. Starter comes with a fused overload that protects unit up to 125% load, only for <b>Power Codes A and G</b> .
<b>Disconnect</b>	Wall Mounted disconnect allows on/off control of fan operation, only for <b>Power Code A</b> .

**Notes:**

1. Contact factory for options requiring different voltages than listed above.
2. See Control Sequences on page 14.

# Options/Accessories

## Vertical Air Outlet – Model UDH

Field Installed Options for Vertical Models	Description
<b>Cone-Jet</b>	The cone-jet allows the unit's discharged air to be adjusted from a direct high velocity stream to a broadened stream that can cover a larger area. See page 31 for additional information.
<b>Truncone</b>	The truncone allows for a broad air stream covering a larger area than possible with a cone-jet. See page 31 for additional information.
<b>One-Way Louver</b>	The one-way louver allows for a one directional discharge of air. See page 31 for additional information.
<b>Two-Way Louver</b>	The two-way louver allows for a bi-directional discharge of air. See page 31 for additional information.
<b>3-Cone Anemostat</b>	The 3-cone anemostat allows for an even air stream covering a larger area than possible with the truncone. See tables 22 and 23 on page 31 for additional information.
<b>4-Cone Anemostat</b>	The 4-cone anemostat allows for an even air stream covering a larger area than possible with the 3-cone anemostat. See page 31 for additional information.

**Cone-Jet**

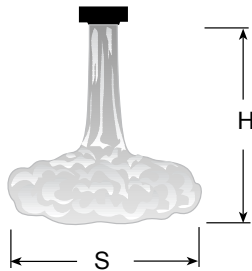

**Louvers**

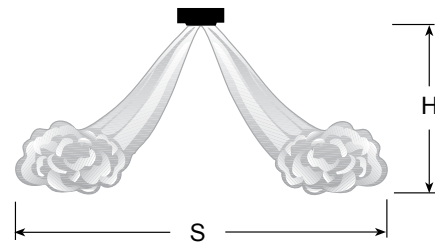

**Truncone**

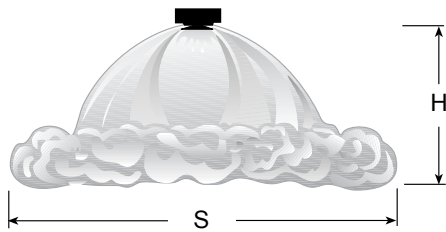

**No Deflector**

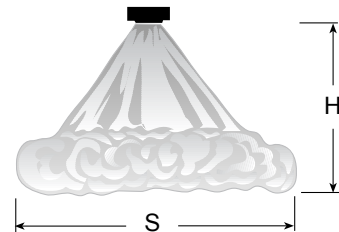

**Anemostat**

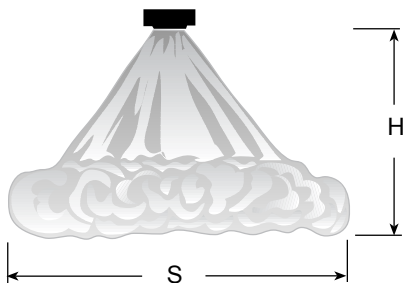

# Options/Accessories

**Table 22 – Vertical Air Outlet Accessory Maximum Height and Spread<sup>1,2,3</sup>**

Model Size	Cone-Jet		Truncone		One-Way Louvers		Two-Way Louvers		3-Cone Anemostat		4-Cone Anemostat	
	Standard		Standard		Standard		Standard		Standard		Standard	
	H	S	H	S	H	S	H	S	H	S	H	S
UDH-42	15	11	8	19	13	11	8	22	8	22	8	28
UDH-59	18	13	9	25	16	14	10	28	9	28	8	35
UDH-78	19	14	11	26	17	15	11	30	11	30	8	30
UDH-95	21	16	11	26	17	15	11	30	11	30	8	30
UDH-139	24	18	13	32	21	18	13	36	13	36	9	45
UDH-161	28	21	14	35	23	20	14	40	14	40	10	50
UDH-193	31	23	16	39	25	22	15	44	16	44	12	55
UDH-212	33	25	16	39	25	22	15	44	16	44	12	55
UDH-247	34	26	17	46	30	26	18	52	17	52	13	65
UDH-279	37	30	18	53	35	30	21	60	18	60	13	75
UDH-333	37	30	17	53	35	30	21	60	17	60	13	75
UDH-385	36	30	17	53	35	30	21	60	17	60	13	75
UDH-500	44	37	19	65	42	37	26	74	19	74	13	93
UDH-610	43	36	19	63	41	41	25	72	—	—	—	—

- 1 Data shown for standard 2 lb. Steam. 60°F entering air temperature conditions. For louvers or cone-jet, data shown for deflectors in fully-opened position. For mounting height/spread at steam pressure other than 2 lb., multiply the value by the correction factor in Table 18 on page 21.
- 2 For mounting height and spread for hot water, multiply the value above by 1.06 to approximate the mounting height and spread at 200°F entering water temperature. For entering water temperature other than 200°F, multiply the value above by 1.06 and then multiply the correction factor in Table 18 on page 21.
- 3 All dimensions in feet.

**Table 23 - Vertical Air Outlet Accessory Dimensions**

Model Size	Cone Jet		Truncone		Louvers		3 - Cone Anemostat		4 - Cone Anemostat	
	L	T	M	X	P	Z	N	AA	N	EE
UDH-42-59	6-1/2	16-1/2	10	25	6-1/2	16-1/2	12-1/2	22-1/2	14	25
UDH-78-95	6-1/2	18-1/2	10	25	6-1/2	18-1/2	12-1/2	24-1/2	14	27
UDH-139-161	8	20-1/2	12	29	8	20-1/2	14	26-1/2	15-1/2	29
UDH-193-212	8	22-1/2	12	29	8	22-1/2	14	28-1/2	15-1/2	31
UDH-247-279	9	24-1/2	14	33	9	24-1/2	15	30-1/2	16-1/2	33
UDH-333-385	9	26-1/2	14	33	9	26-1/2	15	32-1/2	16-1/2	35
UDH-500	10	30-1/2	18	37	10	30-1/2	16	36-1/2	17-1/2	39
UDH-610	10	32-1/2	18	39	10	32-1/2	16	38-1/2	17-1/2	41

\* All dimensions in inches.

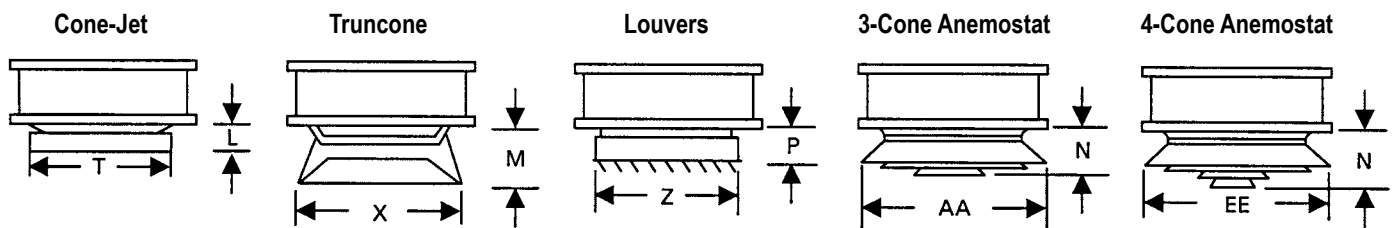

# Piping For Unit Heaters

## Suggested Piping Arrangements – Hot Water Systems

Suggested typical piping arrangements should be verified based on the best industry practices per ASHRAE and ASME Guidelines when selected or approved by a qualified engineer. In addition, piping specialty manufacturer's installation, operating and maintenance literature should be referenced. (See IM 907).

**Horizontal Unit Heater Connected to Overhead Hot Water Mains**

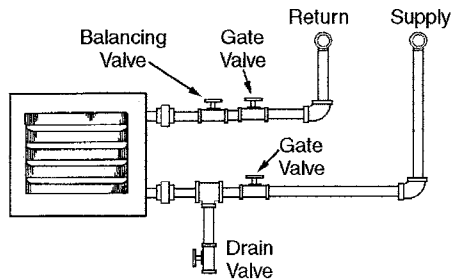

**Vertical Unit Heater Connected to Lower Hot Water Mains**

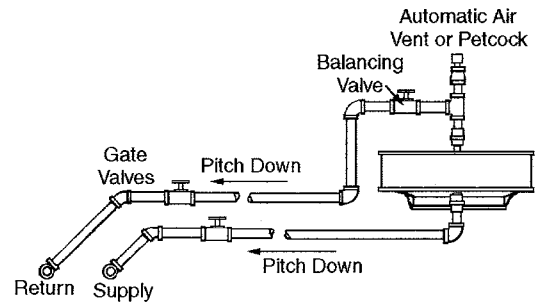

## Steam Systems (UHH-18 through 86)

**Horizontal Unit Heater Side Connection for High Pressure Steam**

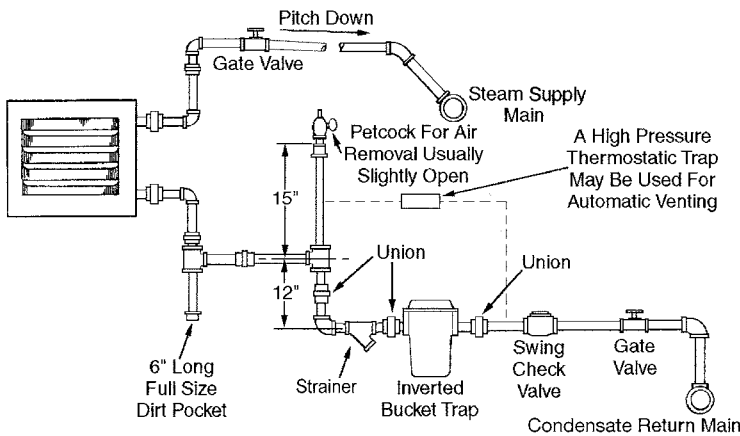

**Horizontal Unit Heater Side Connection for Low Pressure Steam Open Gravity or Vacuum Return Steam**

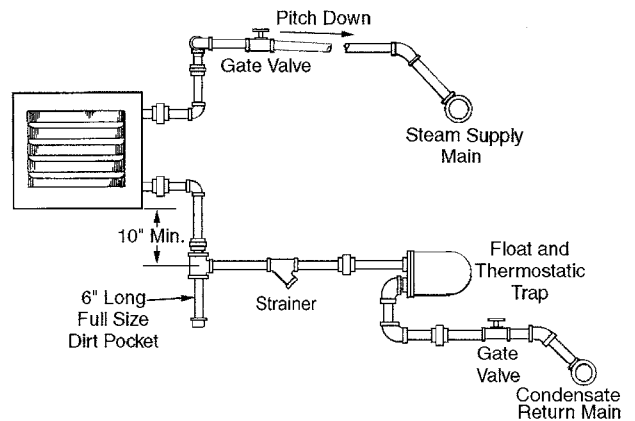

## Steam Systems (UHH-108 through 340)

**Horizontal Unit Heater Top/Bottom Connection for High Pressure Steam**

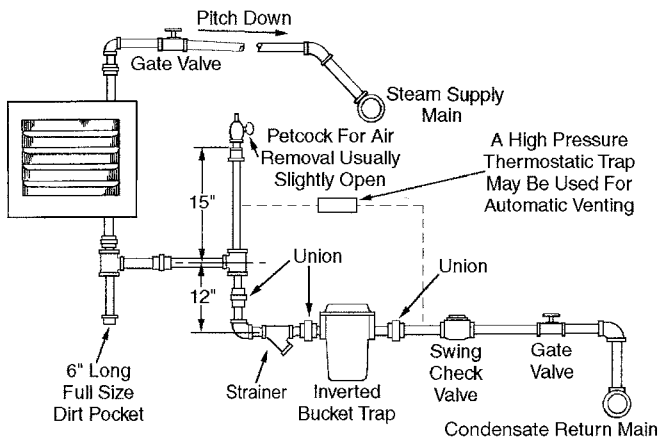

**Horizontal Unit Heater Top/Bottom Connection for Low Pressure Steam Open Gravity or Vacuum Return Steam**

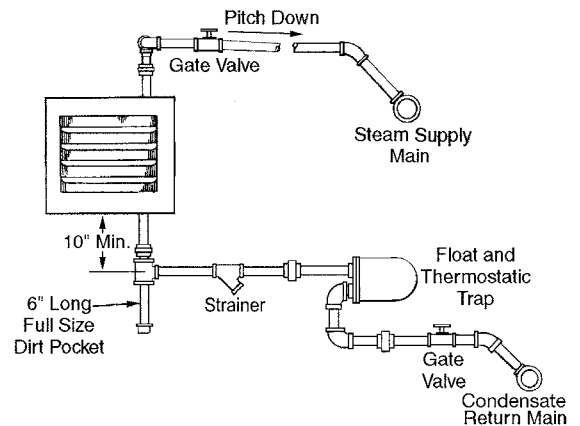



# Guide Specifications

---

## Horizontal Air Delivery Model UHH

### General

Contractors shall furnish and install McQuay Model UHH Horizontal Unit Heaters as indicated or scheduled on the plans. Units to be installed per job specifications in a neat, orderly manner per industry standards and the manufacturer's installation instructions. Materials to be assembled in conformance with ISO-9001:2000 Standards.

### Casing

Casings on all horizontal units are 18-gauge steel and consist of top/back and side halves. Both halves are joined on top and back with Phillips head screws. Top casing is furnished with threaded hanger connections for suspension of unit.

Fan venturi is die-formed on back half.

All models shall be degreased and chemically phosphatized prior to the application of a standard textured gray epoxy powder coating.

### Coils

Heating element is designed for either two-pipe steam or hot water heating system. Coils are made up of 1/2" nominal diameter seamless copper tubing and aluminum fins (12 fins per inch) which are die-formed with a thickness of no less than .010 inches. The fins have integral collars, which provide maximum heat transfer between the tubes and fin. The tubes are mechanically bonded to the fins to ensure permanent contact. Fins are continuous across width and depth of coil and are vertically oriented to resist collection of dirt and foreign particles. Coils are of non-ferrous construction and steel header design for lower pressure drops. Headers have external threaded NPT connections for ease of installation. UHH-18 to UHH-86 have 0.020" tube thickness. Models UHH-108 to UHH-340 have 0.028" tube thickness. Coils are tested at 275 psig air under water. Coils are suitable for operating up to 150 psig steam or 220 psig water and 375°F. Coils have CRN pressure vessel certification for Ontario and Quebec provinces.

### Fans

Motor/fan combination is carefully chosen to minimize noise while maximizing air delivery. Fans have non-conducting aluminum blades, with a steel hub. Each fan blade is balanced and designed specifically for the unit of which it is installed within. Motor on UHH models are attached to a standard (CSA, OSHA) finger-proof fan guard, constructed of steel rod. Air diffusion on UHH models is accomplished through horizontal louvers.

### Motors

Standard motors are 115/60/1, totally enclosed; permanent split capacitor with thermal overload protection and UL Certification. Motors are designed to handle up to 104°F maximum constant ambient temperature.

All motors are designed for horizontal mounting, permanently lubricated for extended reliable motor life.

Explosion-proof and 3-phase motors are available for special needs applications. Explosion-proof ratings per National Electric Code and Canadian Standard Association (CSA) apply.

### Louvers

Units to have adjustable horizontal louvers, 18-gauge steel, color matched with the unit casing. Optional vertical louvers are available for lateral airflow deflection.

### Mounting Hardware

Heavy-duty threaded hardware allows unit to be mounted with threaded rod.

Optional pipe hanger kits available for mounting unit with threaded pipe.

# Guide Specifications

---

## Vertical Air Delivery Model UDH

### General

Contractor shall furnish and install McQuay Model UDH Vertical Unit Heaters as indicated or scheduled on the plans. Units to be installed per job specifications per industry standards and the manufacturer's installation instructions. Materials to be assembled in conformance with ISO-9001:2000 Standards.

### Casing

Casings are formed from rugged 16-gauge steel. Casing on all vertical units are top and bottom pieces joined by corners and additional hardware. Top casing is furnished with threaded hanger connections for suspension of unit.

Die-formed venturi outlet draws air through unit for maximum airflow.

All models shall be degreased and chemically phosphatized prior to the application of a standard textured gray epoxy powder coating.

### Coils

Heating element is designed for either two-pipe steam or hot water heating system. Coils are made up of 1/2" nominal diameter seamless copper tubing and aluminum fins (12 fins per inch) which are die-formed with a thickness of no less than .010 inches. The fins have integral collars, which provide maximum heat transfer between the tubes and fin. The tubes are mechanically bonded to the fins to ensure permanent contact. Fins are continuous across width and depth of coil and are vertically oriented to resist collection of dirt and foreign particles. Coils are of non-ferrous construction with a steel header for lower pressure drops. All UDH units have steel header tubes. Headers have external threaded NPT connections. All model have 0.028" tube thickness. Coils are tested at 275 psig air under water. Coils are suitable for operating up to 150 psig steam or 220 psig water and 375°F. Coils have CRN pressure vessel certification for Ontario and Quebec provinces.

### Fans

To have non-conducting aluminum blades, with a steel hub. Each fan blade is balanced and designed specifically for the unit of which it is installed within. Fans designed to move air efficiently and quietly with minimum power requirements. All UDH models have a CSA and OSHA finger-proof fan guard over the air outlet opening.

### Motors

Standard motors are 115/60/1, totally enclosed; permanent split capacitor with thermal overload protection and UL Certification. Motors are designed to handle up to 104°F maximum constant ambient temperature.

All motors are designed for vertical mounting, permanently lubricated for extended reliable motor life.

Explosion-proof and 3-phase motors are available for special needs applications. National Electric Code and Canadian Standard Association (CSA) apply.

### Junction Box

All unit wiring is contained in an electrical junction box that is mounted to the unit heater casing.

### Air Diffusion

Multiple arrangements available for unlimited air diffusion patterns. Accessories are finished with a epoxy-based powder coating to match unit.

### Louvers

Units to have adjustable horizontal louvers, 18-gauge steel, color matched with the unit casing. Optional vertical louvers are available for lateral airflow deflection.

### Mounting Hardware

Heavy-duty threaded hardware allows unit to mounted with threaded rod. Optional pipe hanger kits available for mounting unit with threaded pipe.

# Metric & English Conversion

## HVAC Conversion Factors (English Units & S.I. Metric)

Dimension	Multiply	By	To obtain
<b>Length</b>	ft	0.3048	m
	m	3.28	ft
	in	2.54	cm
	in	25.4	mm
	cm	0.3937	in
<b>Heat</b>	Ton	12000	Btu/hr
	Ton	3.517	kW
	kW	0.2843	Ton
	Btu/hr	0.2931	W
	W	3.413	Btu/hr
	kW	3413	Btu/hr
	hp	2545	Btu/hr
<b>Power</b>	hp	0.7457	kW
	kW	1.341	hp
<b>Volume</b>	CFM	0.000472	m <sup>3</sup> /s
	m <sup>3</sup> /s	2118.9	CFM
	CFM (ft <sup>3</sup> /min)	0.47195	L/s
	GPM (gal/min)	0.0631	L/s
	U.S. gal	3.785	L
	L	0.264	U.S. gal
	L/s	2.119	CFM
	L/s	15.85	GPM
<b>Velocity</b>	ft/s	0.3048	m/s
	ft/min	0.00508	m/s
	m/s	196.85	ft/min
<b>Pressure</b>	inWG	0.2491	kPa
	inWG	0.03602	Psi
	Pascals	0.00403	inWG
	kPascals	0.145	Psi
	Psi	27.761	inWG
	Psi	6.895	kPascals
<b>Weight</b>	lbs	0.4536	kg

Symbol	Definition
Btu	British Thermal Units
C	Celcius (centigrade)
CFM	Cubic Feet per Minute
cm	Centimeters
F	Fahrenheit
ft	Feet
hp	Horsepower
hr	Hours
in	Inches
kg	Kilograms
kW	Kilowatts
L	Liters
lb	Pounds
m	Meters
mm	Millimeters
min	Minutes
Pa	Pascals
psi	Pounds per Square Inch
s	Seconds
Ton	Tons Refrigeration
W	Watts
WG	Water Gauge

$$^{\circ}\text{F} = \frac{9}{5}\text{C} + 32 \quad ^{\circ}\text{C} = \frac{5}{9}(\text{F} - 32)$$



### **McQuay Training and Development**

Now that you have made an investment in modern, efficient McQuay equipment, its care should be a high priority. For training information on all McQuay HVAC products, please visit us at [www.mcquay.com](http://www.mcquay.com) and click on training, or call 540-248-9646 and ask for the Training Department.

### **Warranty**

All McQuay equipment is sold pursuant to its standard terms and conditions of sale, including Limited Product Warranty. Consult your local McQuay Representative for warranty details. Refer to Form 933-43285Y. To find your local McQuay Representative, go to [www.mcquay.com](http://www.mcquay.com).

This document contains the most current product information as of this printing. For the most up-to-date product information, please go to **[www.mcquay.com](http://www.mcquay.com)**.

